

**ROCKSHOX**

**ZEB**

**LYRIK**

**PIKE**

2023+  
ZEB, Lyrik, Pike



SERVICE MANUAL



# **SAFETY FIRST!**

We care about YOU. Please, always wear your safety glasses and protective gloves when servicing RockShox products.

Protect yourself! Wear your safety gear!

## **⚠️ WARNING - PRESSURIZED DEVICE**

Suspension products may contain pressurized air, nitrogen, springs, and oil.

Always wear certified safety glasses (ANSI Z87.1, EN166 EU) when performing any service on a suspension product (suspension fork, rear shock, seatpost).

Failure to wear proper safety glasses can result in **SERIOUS INJURY OR DEATH.**

## RockShox Service

We recommend that you have your RockShox suspension serviced by a qualified bicycle mechanic. Servicing RockShox suspension requires knowledge of suspension components, as well as the use of specialized tools and lubricants/fluids. Failure to follow the procedures outlined in this service manual may cause damage to your component and void the warranty.

Visit [www.sram.com/service](http://www.sram.com/service) for the latest *RockShox Spare Parts Catalog* and technical information. For order information, please contact your local SRAM distributor or dealer.

Information contained in this publication is subject to change at any time without prior notice.

Your product's appearance may differ from the pictures contained in this publication.



For recycling and environmental compliance information, please visit: [www.sram.com/en/company/about/environmental-policy-and-recycling](http://www.sram.com/en/company/about/environmental-policy-and-recycling).

## Suspension Safety Precautions and Warnings

### SAFETY INSTRUCTIONS

To avoid serious injury or death, you MUST understand and follow the safety information in this document.

#### **⚠ WARNING - PRESSURIZED DEVICE**

Suspension products may contain pressurized air, nitrogen, springs, and oil.

Always wear certified safety glasses (ANSI Z87.1, EN166 EU) when performing any service on a suspension product (suspension fork, rear shock, seatpost).

DO NOT attempt to disassemble a suspension product before the product is fully depressurized. Follow depressurization procedures and remove the air valve as instructed, before attempting disassembly of a suspension product.

When performing service on a suspension product, keep your eyes, face, and body away from any part or lubricant that can suddenly eject under high pressure. DO NOT direct any pressurized suspension part at a person.

DO NOT attempt to puncture, crush, or incinerate any assembled suspension product.

**Failure to follow these preventative measures can result in SERIOUS INJURY OR DEATH.**

#### **⚠ WARNING - CRASH HAZARD**

Parts must be tightened to the specified torque.

To avoid separation of parts, threadlocker must be applied as instructed. Failure to apply threadlocker could result in separation of the parts.

Retaining rings must be fully seated in the retaining ring groove. Confirm the retaining ring is fully seated in the retaining ring groove after installation.

Do not use vinegar of any type to clean any part of a RockShox suspension product. Vinegar can cause permanent damage to parts which can, over time, result in product structural failure.

**Failure to follow these preventative measures can result in SERIOUS INJURY OR DEATH.**

#### **⚠ WARNING**

Do not ingest oil, fluid, grease, lubricant, or cleaner. Ingestion could lead to SERIOUS INJURY OR DEATH. Seek immediate medical attention if any oil, fluid, grease, lubricant, or cleaner is ingested.

#### **⚠ CAUTION**

Suspension products may contain lubricants which can lead to skin irritation. Always wear nitrile gloves when servicing suspension products. Failure to properly protect your skin can result in irritation. Seek medical attention if your skin is adversely affected by any suspension oil, fluid, grease, lubricant, and/or cleaner.

Always wear safety glasses. Do not allow oil, fluid, grease, lubricant, or cleaner to contact your eyes or face. Seek immediate medical attention if irritation occurs.

Use care when working with sharp tools and parts. Never use sharp tools coated with oil and/or grease. Clean and remove all oil and/or grease from your hands and gloves, and tools before working with any sharp tool or part. Failure to do so can result in personal injury.

Place an oil pan on the floor underneath the product during service to catch any drained or spilled fluids. To avoid a slip and fall, and possible injury or harm, immediately clean any oil, fluid, grease, or lubricant from the floor in your work area.

# TABLE OF CONTENTS

<b>ROCKSHOX SERVICE</b> .....	<b>3</b>
<b>SUSPENSION SAFETY PRECAUTIONS AND WARNINGS</b> .....	<b>3</b>
<b>PREPARACIÓN DE LAS PIEZAS Y PROCEDIMIENTOS DE MANTENIMIENTO</b> .....	<b>6</b>
PART PREPARATION .....	6
SERVICE PROCEDURES.....	6
MODEL CODE IDENTIFICATION .....	7
WARRANTY AND TRADEMARK.....	7
PARTS, TOOLS, AND SUPPLIES .....	8
RECOMMENDED SERVICE INTERVALS.....	9
RECORD YOUR SETTINGS.....	9
TORQUE VALUES .....	10
OIL VOLUME AND LUBRICANT .....	11
<b>EXPLODED VIEW</b> .....	<b>12</b>
2023+ (A2) ZEB ULTIMATE - CHARGER 3 RC2 - DEBONAIR+.....	12
2023+ (A2) ZEB ULTIMATE - CHARGER 3 RC2 - DUAL POSITION AIR .....	13
2023+ (A2) ZEB SELECT+ - CHARGER 3 RC2 - DEBONAIR+ .....	14
2023+ (A2) ZEB SELECT+ - CHARGER 3 RC2 - DUAL POSITION AIR.....	15
2023+ (A2) ZEB SELECT - CHARGER RC - DEBONAIR+ .....	16
2023+ (A2) ZEB SELECT - CHARGER RC - DUAL POSITION AIR .....	17
2023+ (A2) ZEB BASE - RUSH RC - DEBONAIR+.....	18
2023+ (A2) ZEB BASE - RUSH RC - DUAL POSITION AIR.....	19
2023+ (D1) LYRIK ULTIMATE - CHARGER 3 RC2 - DEBONAIR+ .....	20
2023+ (D1) LYRIK SELECT+ - CHARGER 3 RC2 - DEBONAIR+.....	21
2023+ (D1) LYRIK SELECT - CHARGER RC - DEBONAIR+.....	22
2023+ (D1) LYRIK BASE - RUSH RC - DEBONAIR+ .....	23
2023+ (C1) PIKE ULTIMATE - CHARGER 3 RC2 - DEBONAIR+.....	24
2023+ (C1) PIKE SELECT+ - CHARGER 3 RC2 - DEBONAIR+ .....	25
2023+ (C1) PIKE SELECT - CHARGER RC - DEBONAIR+ .....	26
2023+ (C1) PIKE BASE - RUSH RC - DEBONAIR+.....	27
LOWER LEG FEATURES - ZEB, LYRIK, PIKE.....	28
BUTTERCUPS - ZEB, LYRIK, PIKE - ULTIMATE - CHARGER 3 RC2 AND DEBONAIR+ .....	29
<b>LOWER LEG REMOVAL AND SERVICE</b> .....	<b>30</b>
<b>50/200 HOUR SERVICE</b>	
LOWER LEG REMOVAL.....	30
<b>50 HOUR SERVICE</b>	
LOWER LEG SERVICE.....	37
<b>200 HOUR SERVICE</b>	
LOWER LEG SEAL SERVICE.....	39
<b>DEBONAIR+ - AIR SPRING SERVICE, TRAVEL CHANGE, AND BUTTERCUPS UPGRADE</b> .....	<b>42</b>
<b>200 HOUR SERVICE</b>	
AIR SPRING REMOVAL .....	42
BUTTERCUPS REMOVAL - DEBONAIR+ - ULTIMATE.....	48
DEBONAIR+ AIR SPRING TRAVEL CHANGE (OPTIONAL) .....	50
DEBONAIR+ BOTTOMLESS TOKENS .....	54
DEBONAIR+ BOTTOMLESS TOKENS INSTALLATION (OPTIONAL).....	54
AIR SPRING SERVICE.....	55
BUTTERCUPS INSTALLATION - DEBONAIR+ - ULTIMATE .....	60
AIR SPRING INSTALLATION.....	63
<b>DUAL POSITION AIR (DPA) - ZEB - AIR SPRING SERVICE</b> .....	<b>68</b>
<b>200 HOUR SERVICE</b>	
AIR SPRING REMOVAL .....	68
DPA AIR SPRING TRAVEL AND BOTTOMLESS TOKENS .....	72
DPA BOTTOMLESS TOKENS INSTALLATION (OPTIONAL) .....	72
DPA AIR SPRING TRAVEL CHANGE AND BOTTOMLESS TOKENS (OPTIONAL) .....	73
AIR SPRING SERVICE.....	73
AIR SPRING INSTALLATION.....	75



**DAMPER SERVICE - CHARGER 3 RC2 ..... 79**

200 HOUR SERVICE

CONTROLS REMOVAL - CHARGER 3 RC2..... 79  
DAMPER REMOVAL - CHARGER 3 RC2 ..... 81  
BUTTERCUPS REMOVAL - CHARGER 3 RC2 - ULTIMATE ..... 82  
DAMPER SERVICE - CHARGER 3 RC2..... 84  
DAMPER ASSEMBLY - CHARGER 3 RC2 ..... 92  
BUTTERCUPS INSTALLATION - CHARGER 3 RC2 - ULTIMATE ..... 102  
DAMPER BLEED - CHARGER 3 RC2..... 105  
TEST COMPRESSION - CHARGER 3 RC2..... 109  
DAMPER INSTALLATION - CHARGER 3 RC2..... 110  
CONTROLS INSTALLATION - CHARGER 3 RC2 ..... 112

**DAMPER SERVICE - CHARGER RC ..... 115**

200 HOUR SERVICE

CONTROLS REMOVAL - CHARGER RC..... 115  
DAMPER REMOVAL - CHARGER RC ..... 116  
DAMPER SERVICE - CHARGER RC ..... 117  
DAMPER ASSEMBLY - CHARGER RC..... 121  
TEST COMPRESSION - CHARGER RC..... 126  
DAMPER INSTALLATION - CHARGER RC..... 127  
CONTROLS INSTALLATION - CHARGER RC ..... 129

**DAMPER SERVICE - RUSH RC ..... 130**

200 HOUR SERVICE

CONTROLS REMOVAL - RUSH RC..... 130  
DAMPER REMOVAL - RUSH RC ..... 131  
DAMPER SERVICE - RUSH RC..... 132  
DAMPER ASSEMBLY - RUSH RC ..... 135  
TEST COMPRESSION - RUSH RC..... 139  
DAMPER INSTALLATION - RUSH RC..... 140  
CONTROLS INSTALLATION - RUSH RC ..... 142

**LOWER LEG ASSEMBLY ..... 143**

50/200 HOUR SERVICE

LOWER LEG INSTALLATION ..... 143

## Part Preparation

Remove the component from the bicycle before service.

Disconnect and remove the remote cable or hydraulic hose from the fork or rear shock, if applicable. For additional information about RockShox remotes, user manuals are available at [www.sram.com](http://www.sram.com).

Clean the exterior of the product with mild soap and water to avoid contamination of internal sealing part surfaces.

## Service Procedures

The following procedures should be performed throughout service, unless otherwise specified.

Clean the part with RockShox Suspension Cleaner or isopropyl alcohol and a clean, lint-free shop towel. For hard to reach places (e.g. upper tube, lower leg), wrap a clean, lint-free shop towel around a non-metallic dowel to clean the inside.

Clean the sealing surface on the part and inspect it for scratches.

### **⚠ WARNING - CRASH HAZARD**

DO NOT use vinegar of any type to clean any part of a RockShox suspension product. Vinegar can cause permanent damage to parts which can, over time, result in product structural failure, serious injury, and possibly death.

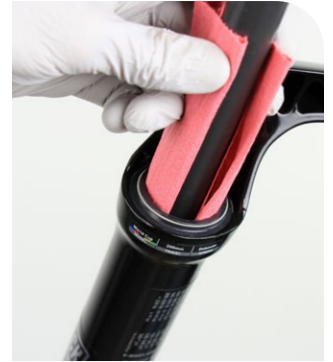

Replace the o-ring or seal with a new one from the service kit. Use your fingers or a pick to pierce and remove the old seal or o-ring.

Apply grease to the new seal or o-ring.

### **NOTICE**

Do not scratch any sealing surfaces when servicing the product. Scratches can cause leaks. Consult the spare parts catalog to replace the damaged part.

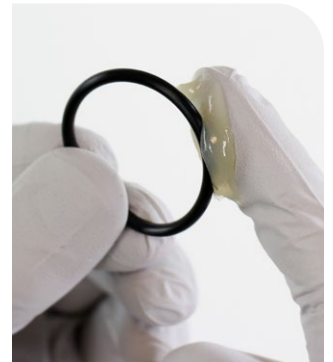
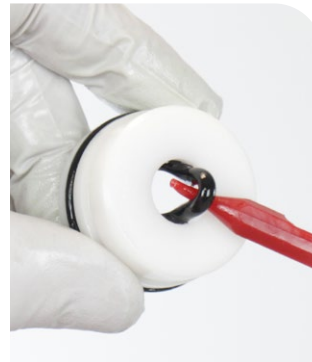

Use aluminum soft jaws when placing a part in a bench vise.

Tighten the part with a torque wrench to the torque value listed in the red bar. When using a crowfoot socket and torque wrench, install the crowfoot socket at 90 degrees to the torque wrench.

### **⚠ WARNING - CRASH HAZARD**

Parts must be tightened to the specified torque. Failure to do so can result in SERIOUS INJURY OR DEATH.



## Model Code Identification

Product model code and specification details can be identified with the serial number on the product. Model codes can be used to identify the product type, series name, model name, and product version associated with the production model year. Product details can be used to identify spare parts, service kit, and lubricant compatibility.

Model Code example: **FS-LYRK-ULT-D1**

**FS** = Product Type - **Front Shock/Suspension**

**LYRK** = Platform/Series - **Lyrik**

**ULT** = Model - **Ultimate**

**D1** = Version - (**D** - fourth generation, **1** - first iteration)

To identify the model code, locate the serial number on the product and enter it into the **Search by Model Name or Serial Number** field at [www.sram.com/service](http://www.sram.com/service).

## Warranty and Trademark

For SRAM Warranty information, visit: [www.sram.com/warranty](http://www.sram.com/warranty).

For SRAM Trademark information, visit: [www.sram.com/website-terms-of-use](http://www.sram.com/website-terms-of-use).

### Parts

- 2023+ (A2) ZEB - 200 Hour Service Kit
- 2023+ (D1) Lyrik - 200 Hour Service Kit
- 2023+ (C1) Pike - 200 Hour Service Kit
- DebonAir+ Air Spring Shaft assembly (optional travel change)
- DebonAir+ Upgrade Kit : Air Spring assembly with ButterCups
- Charger 3 RC2 Ultimate Upgrade Kit : Damper assembly with ButterCups

### Safety and Protection Supplies

- Apron
- Clean, lint-free shop towels
- Nitrile gloves
- Oil pan
- Safety glasses

### Lubricants and Fluids

- Maxima PLUSH 3wt Suspension Oil (Charger RC, Rush RC)
- Maxima PLUSH 7wt Suspension Oil (Charger 3 RC2)
- Maxima PLUSH Dynamic Suspension Lube Heavy (air spring)
- Maxima PLUSH Dynamic Suspension Lube Light (lower legs)
- RockShox Suspension Cleaner or isopropyl alcohol
- SRAM Butter Grease
- Threadlocker Loctite Red 2760 or equivalent
- Threadlocker Loctite Blue 242 or equivalent

### RockShox Tools

- Charger Vise Blocks (Charger RC)
- RockShox Bleed Syringe
- RockShox Dust Seal Installation Tool (38 mm) or [RockShox x Abbey Bike Tools 38 mm Flangeless Dust Seal Installation Tool](#)
- RockShox Dust Seal Installation Tool (35 mm) or [RockShox x Abbey Bike Tools 35 mm Flangeless Dust Seal Installation Tool](#)
- RockShox Reverb Vise Blocks (Charger 3 RC2, Rush RC)
- RockShox Schrader Valve Tool
- RockShox Shock Pump
- RockShox Top Cap/Cassette Tool (3/8" / 24 mm) or [RockShox x Abbey Bike Tools Top Cap/Cassette Tool](#)

### Bicycle Tools

- Bicycle work stand
- Downhill tire lever
- Shock pump

### Common Tools

- Adjustable wrench or open end wench: 19, 23, 25, 28 mm
- Bench vise with aluminum soft jaw inserts
- Crowfoot: 19, 23, 25, 28 mm
- Hex bit sockets: 1.5, 2, 2.5, 4, 5 mm
- Hex wrenches: 1.5, 2, 2.5, 4, 5, 8 mm
- Internal retaining ring pliers (large) - air spring retaining ring (ZEB)
- Long plastic or wooden dowel
- Pick (metallic) - air spring retaining ring (Lyrik/Pike)
- Pick (non-metallic) - for all o-rings and seals
- Plastic mallet
- Plastic tube (split conduit loom) or similar - air spring and damper shaft protective cover
- Socket: 24 mm
- Socket wrench
- Torque wrench
- TORX bit socket: T25
- TORX wrench: T25

## Recommended Service Intervals

Regular service is required to keep your RockShox product working at peak performance. Follow this maintenance schedule and install the service parts included in each service kit that corresponds with the Service Hours Interval recommendation below. For spare part kit contents and details, refer to the *RockShox Spare Parts Catalog* at [www.sram.com/service](http://www.sram.com/service).

Service Hours Interval	Maintenance	Benefit
Every ride	Clean dirt from upper tubes and wiper seals	Extends wiper seal lifespan
		Minimizes damage to upper tubes
		Minimizes lower leg contamination
Every 50 hours	Perform lower leg service	Restores small bump sensitivity
		Reduces friction
		Extends bushing lifespan
Every 200 hours	Perform damper and spring service	Extends suspension lifespan
		Restores small bump sensitivity
		Restores damping performance

## Record Your Settings

Use the table below to record your suspension settings to return your suspension to its pre-service settings. Record your service dates to track service intervals.

Service Hours Interval	Date of Service	Air Pressure	LSC setting - Count the number of clicks while turning the LSC adjuster fully counterclockwise.	HSC (RC2) setting - Count the number of clicks while turning the HSC adjuster fully counterclockwise.	Rebound setting - Count the number of clicks while turning the rebound adjuster fully counterclockwise.
50					
100					
150					
200					

## Torque Values

Part	Tool	Torque
Air spring shaft insert (Select+, Select, Base - DebonAir+ only)	5 mm hex bit socket	4 N•m (32 in-lb)
Bottom bolt - air spring and damper	5 mm hex bit socket	6.8 N•m (60 in-lb)
Bottomless Token	8 mm hex bit socket	4 N•m (32 in-lb)
ButterCups housing shaft end plate - end plate to shaft - Air Spring	TORX T25 bit socket	4 N•m (32 in-lb)
ButterCups housing (upper) to ButterCups housing (lower) - Air Spring	25 mm crow foot	14 N•m (125 in-lb)
ButterCups housing shaft end plate - end plate to shaft - Damper	TORX T25 bit socket	5 N•m (45 in-lb)
ButterCups housing (upper) to ButterCups housing (lower) - Damper	25 mm crow foot	14 N•m (125 in-lb)
Cam set screw - compression damper adjuster (HSC) x2	1.5 mm hex bit socket	0.56 N•m (5 in-lb)
Lower Leg Plug	4 mm hex bit socket	2 N•m (17 in-lb)
Piston nut - compression damper - Charger 3 RC2 (Ultimate, Select+)	3 mm hex bit socket	1.13 N•m (10 in-lb)
Retaining screw - compression adjuster knob - Charger RC (Select)	2.5 mm hex bit socket	1.35 N•m (12 in-lb)
Retaining screw - compression adjuster knob - Rush RC (Base)	2.5 mm hex bit socket	0.75 - 1.10 N•m (6.6 - 9.7 in-lb)
Retaining screw - low speed compression adjuster knob - Charger 3 RC2 (Ultimate, Select+)	2.5 mm hex bit socket	0.56 N•m (5 in-lb)
Sealhead (rebound) to damper cartridge tube to damper top cap - Charger 3 RC2 (Ultimate, Select+)	23 mm crowfoot	14 N•m (125 in-lb)
Sealhead (rebound) to damper cartridge tube to damper top cap - Charger RC (Select), Rush RC (Base)	19 mm crow foot	17 N•m (150 in-lb)
Set screw - high speed compression adjuster knob - Charger 3 RC2 (Ultimate, Select+)	2.5 mm hex bit socket	0.28 N•m (2.5 in-lb)
Set screw - rebound adjuster knob	2.5 mm hex bit socket	0.84 N•m (7.5 in-lb)
Top cap - compression damper	RockShox Top Cap/Cassette Tool (or standard cassette tool)	28 N•m (250 in-lb)
Top cap - DebonAir+ spring		
Top cap - Dual Position Air spring		



# Oil Volume and Lubricant

Model Year	Fork	Model	Damper				Spring							
			Damper	Upper Tube		Lower Leg		Spring	Upper Tube			Lower Leg		
				Oil Weight	Volume (mL)	Oil	Volume (mL)		Oil	Volume (mL)	Grease	Oil	Volume (mL)	
(+)	(-)													
2023+	ZEB (A2)	Ultimate Select+	Charger 3 RC2	Maxima PLUSH 7wt	Bleed	Maxima PLUSH Dynamic Suspension Lube Light	30	DebonAir+ Dual Position Air	Maxima PLUSH Dynamic Suspension Lube Heavy	3	1	SRAM Butter Grease Grease air piston	Maxima PLUSH Dynamic Suspension Lube Light	15
		Select	Charger RC	Maxima PLUSH 3wt										
		Base	Rush RC											
	Lyrik (D1) Pike (C1)	Ultimate Select+	Charger 3 RC2	Maxima PLUSH 7wt										
		Select	Charger RC	Maxima PLUSH 3wt										
		Base	Rush RC											

Use ONLY RockShox, SRAM, and Maxima suspension oils/fluids and grease, unless otherwise specified. Use of any other lubricants can damage seals and decrease performance.

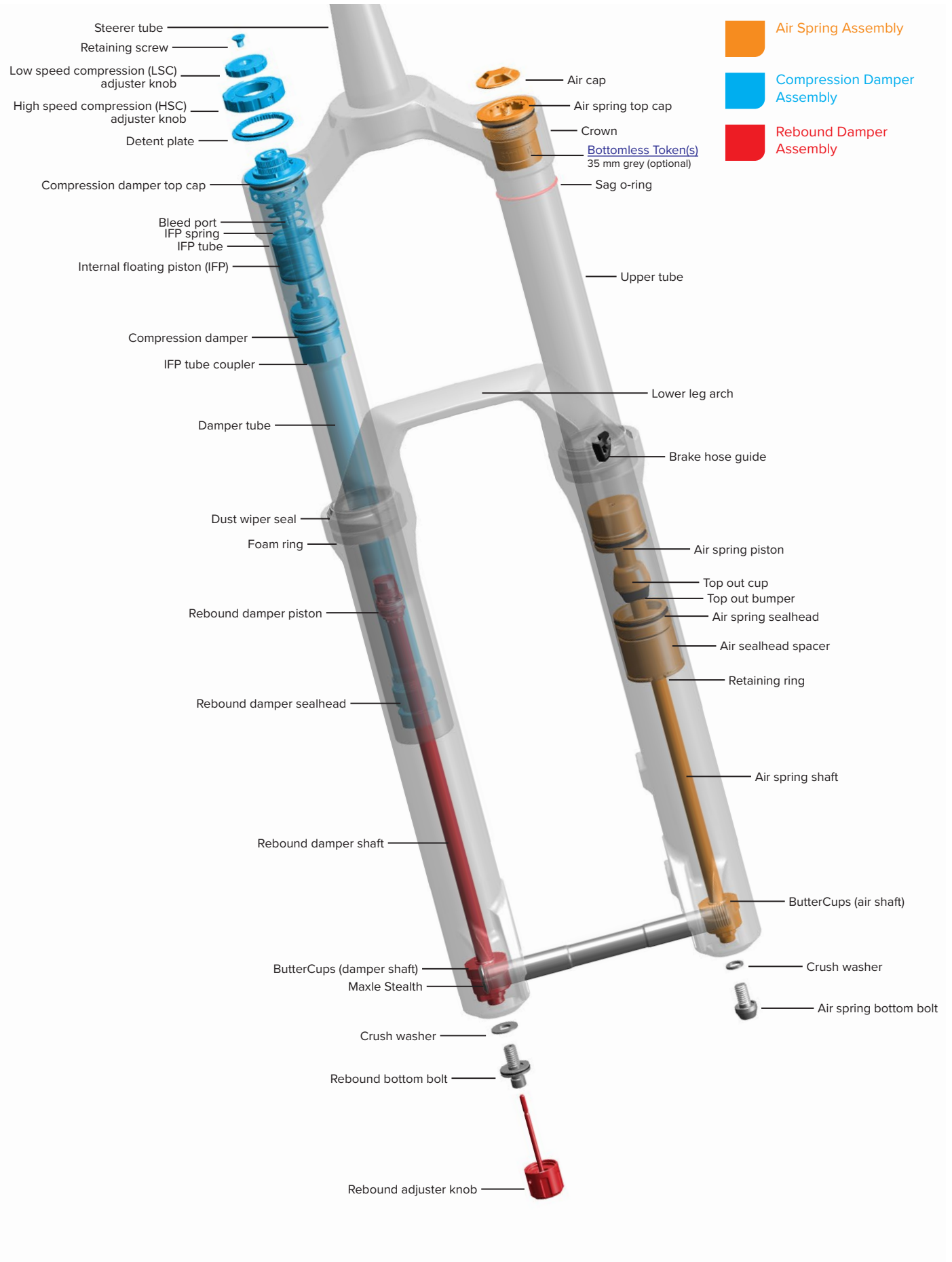

2023+ (A2) ZEB Ultimate - Charger 3 RC2 - Dual Position Air

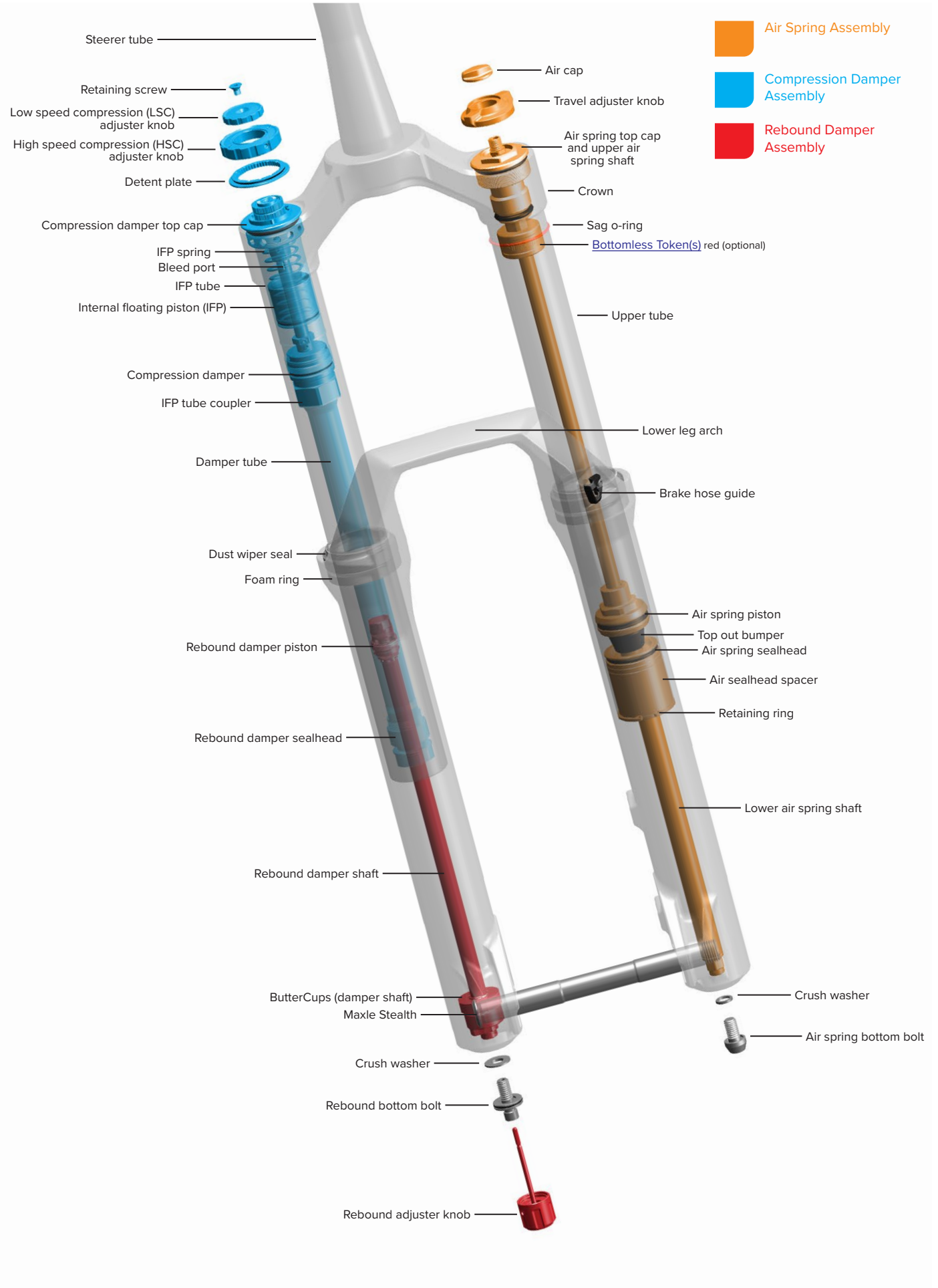

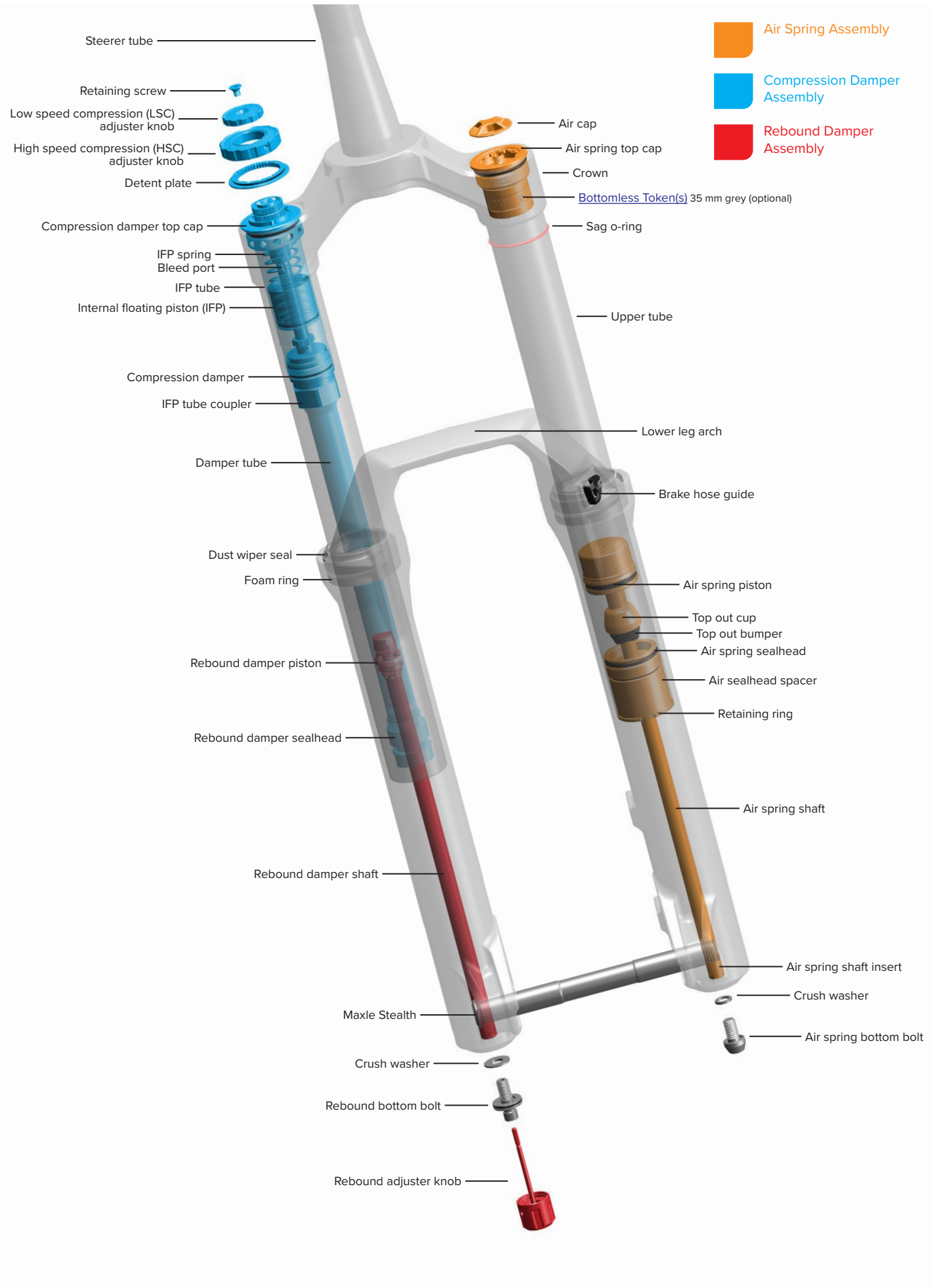

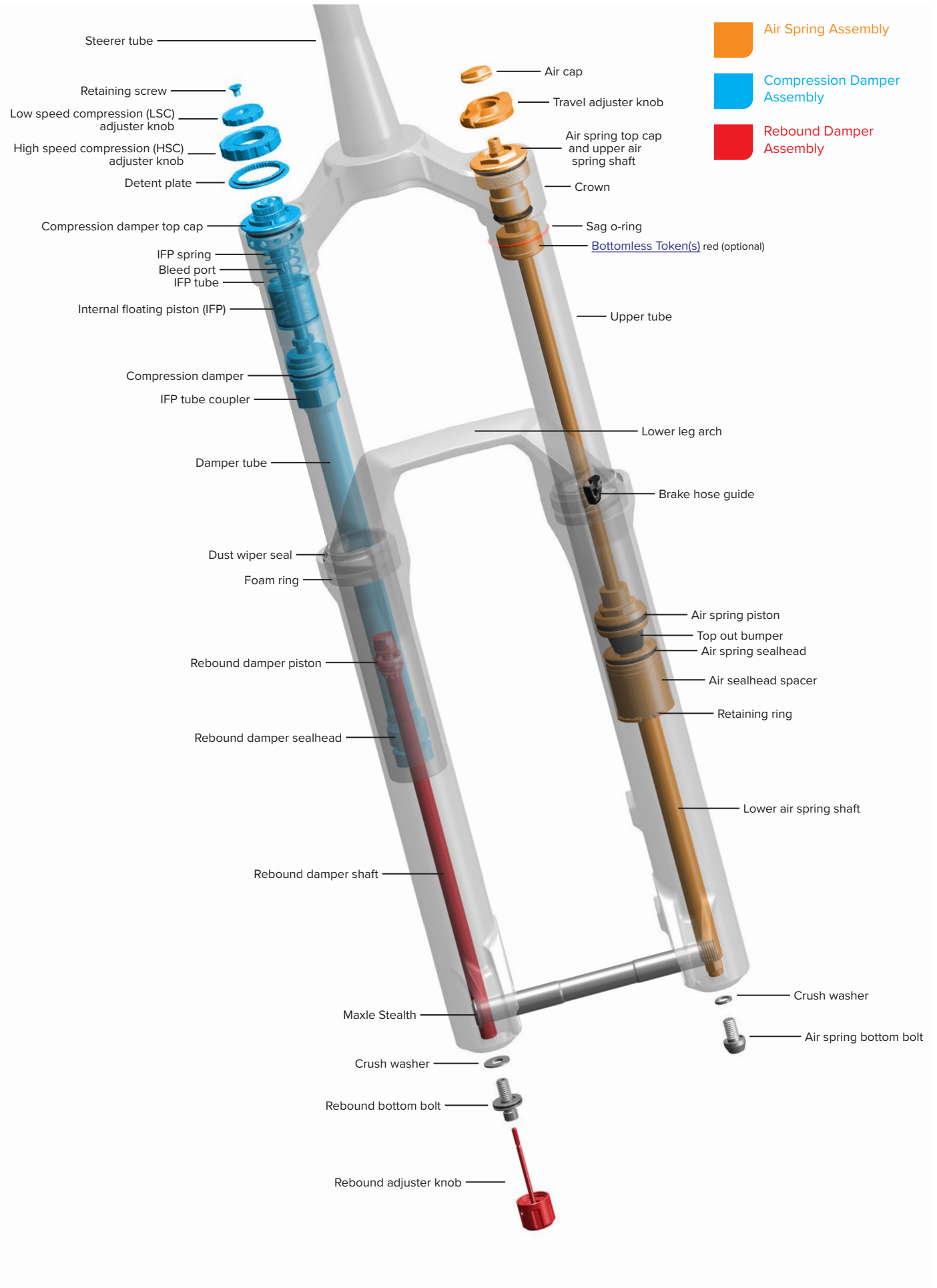

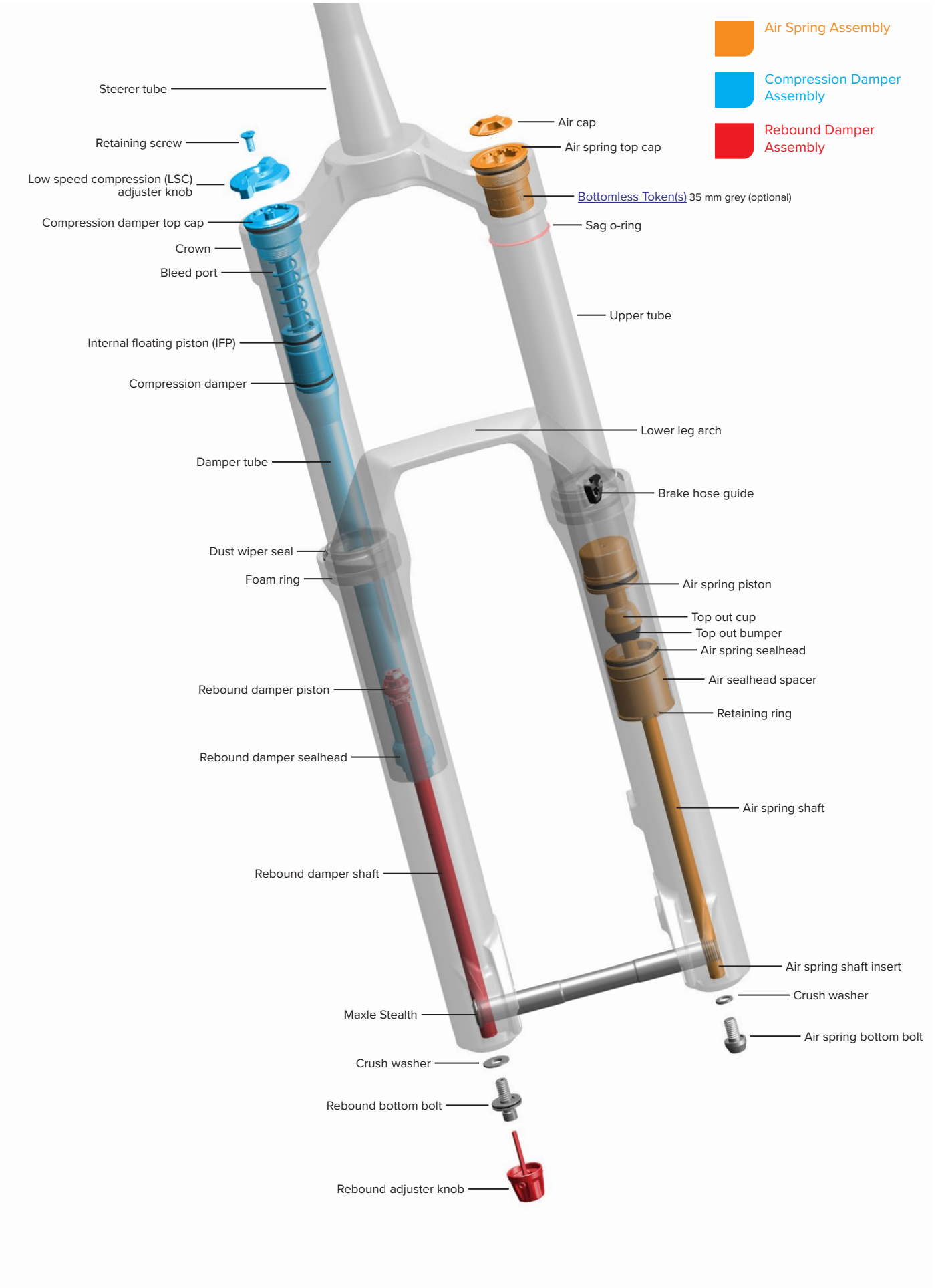



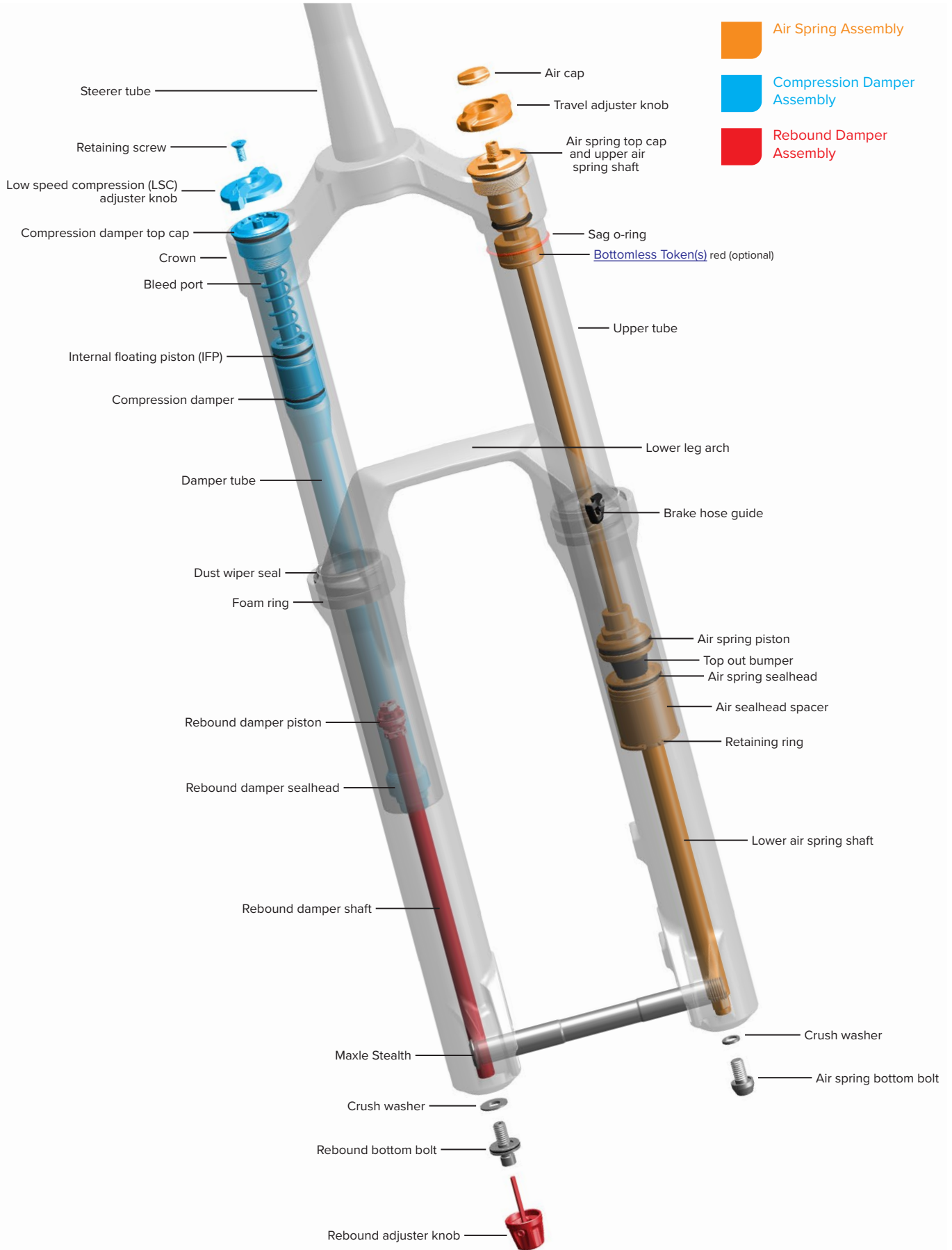

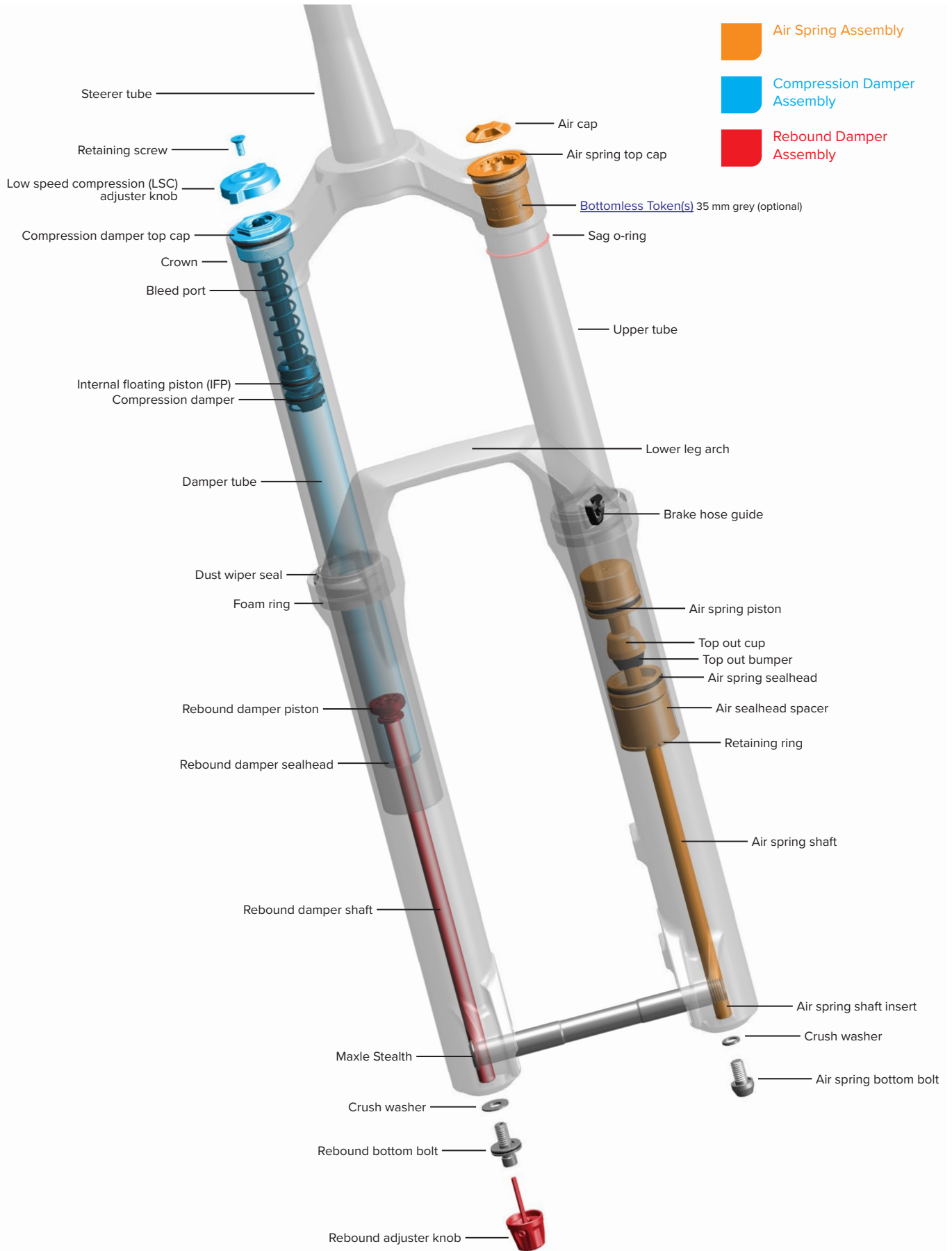

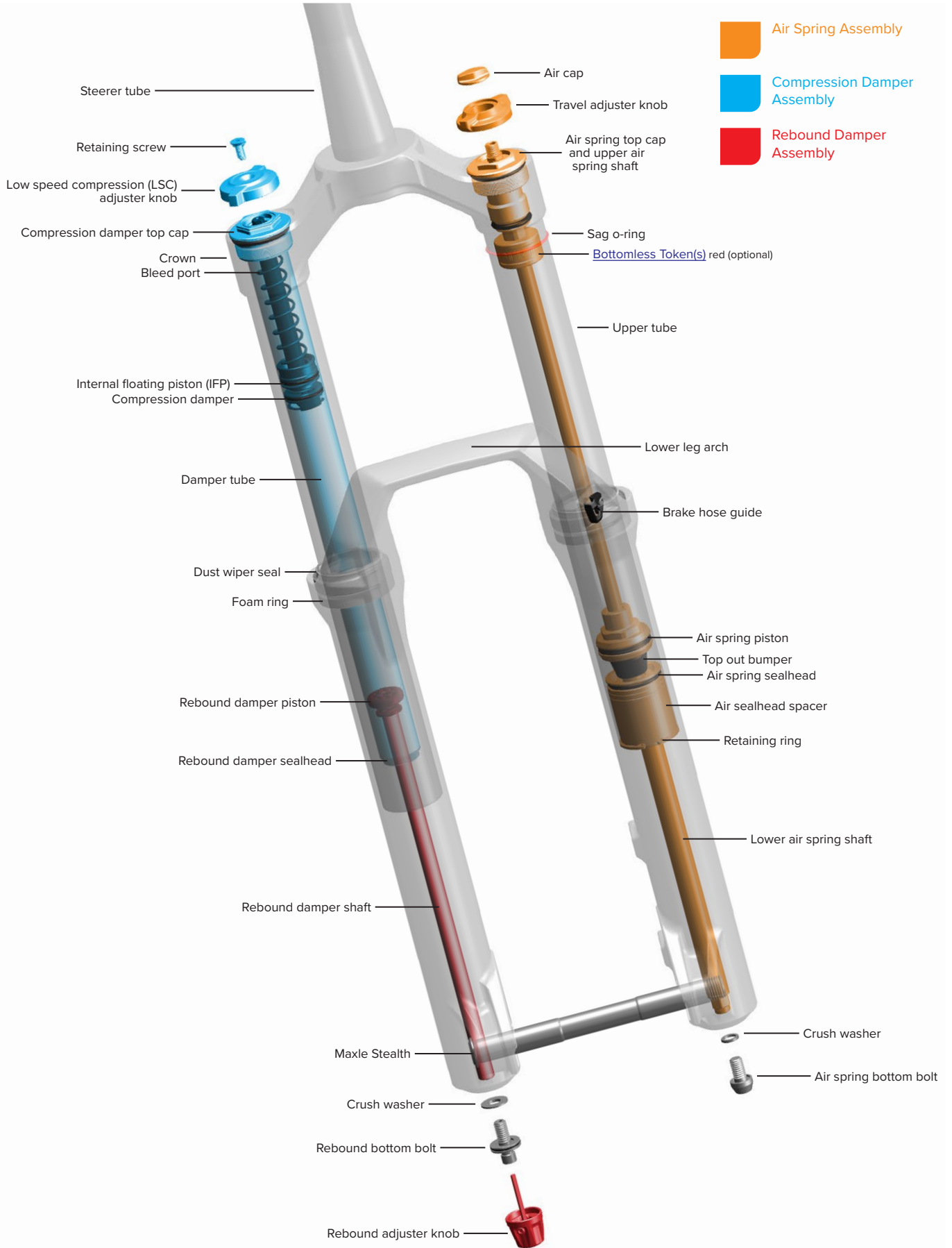

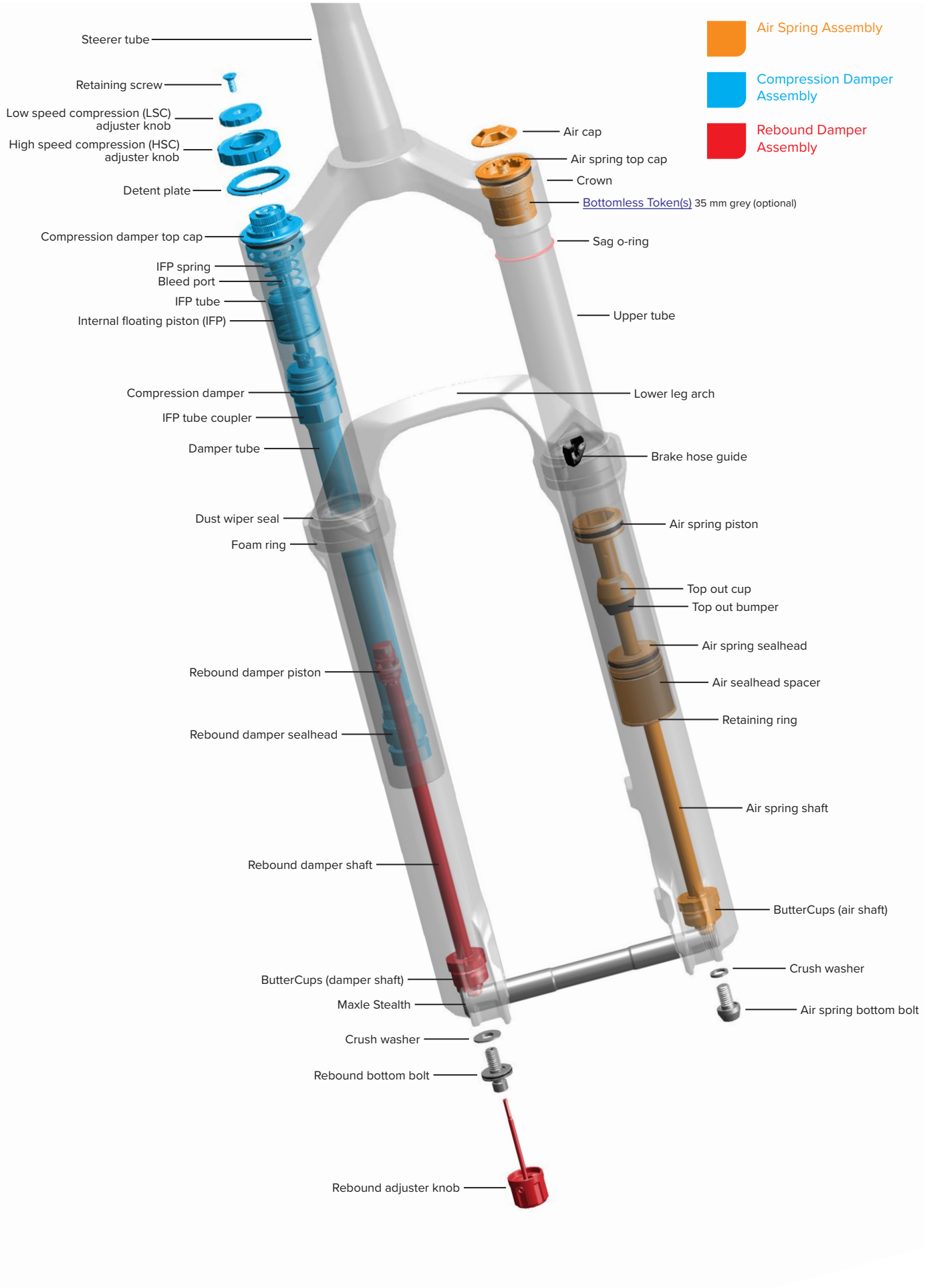

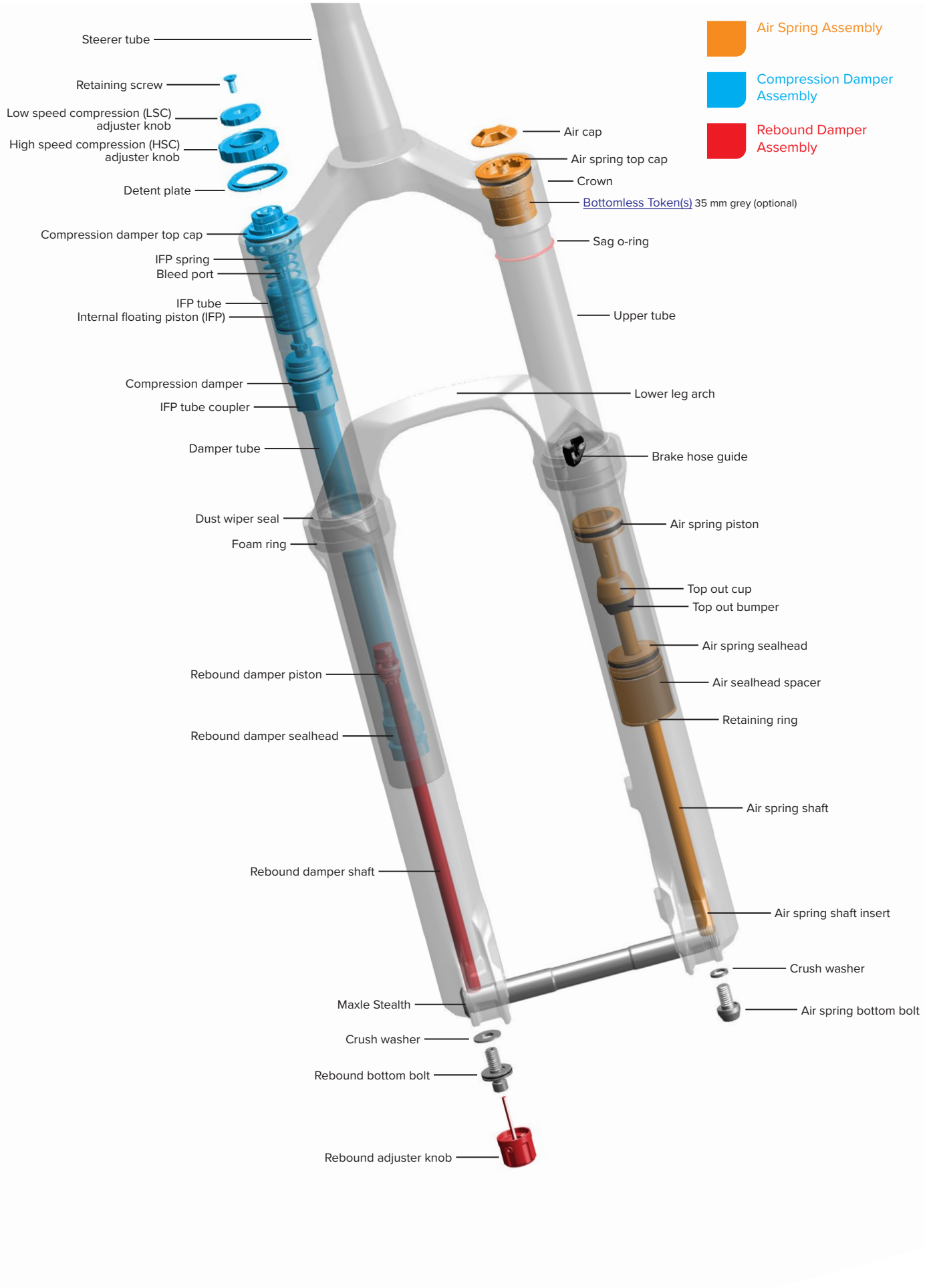

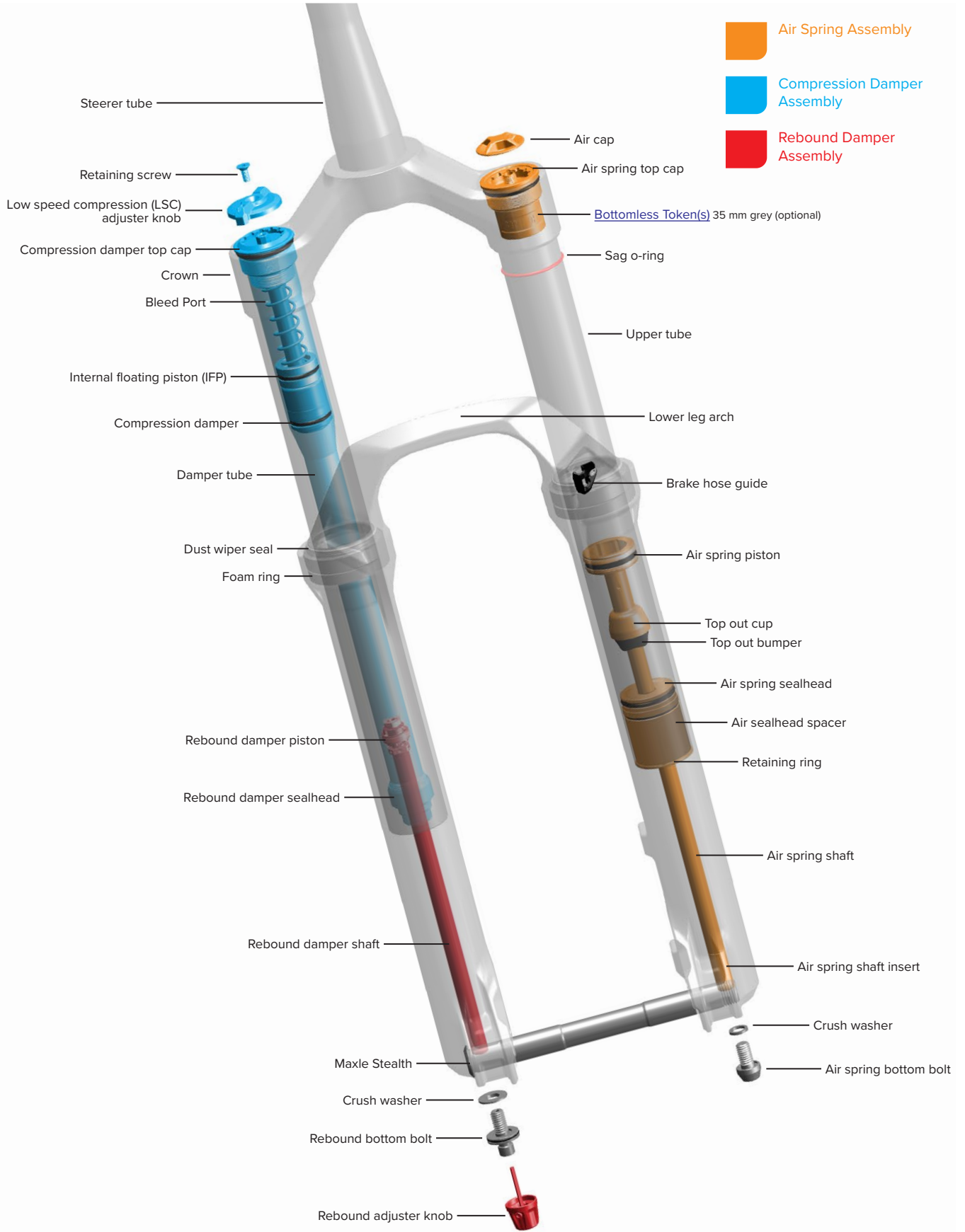



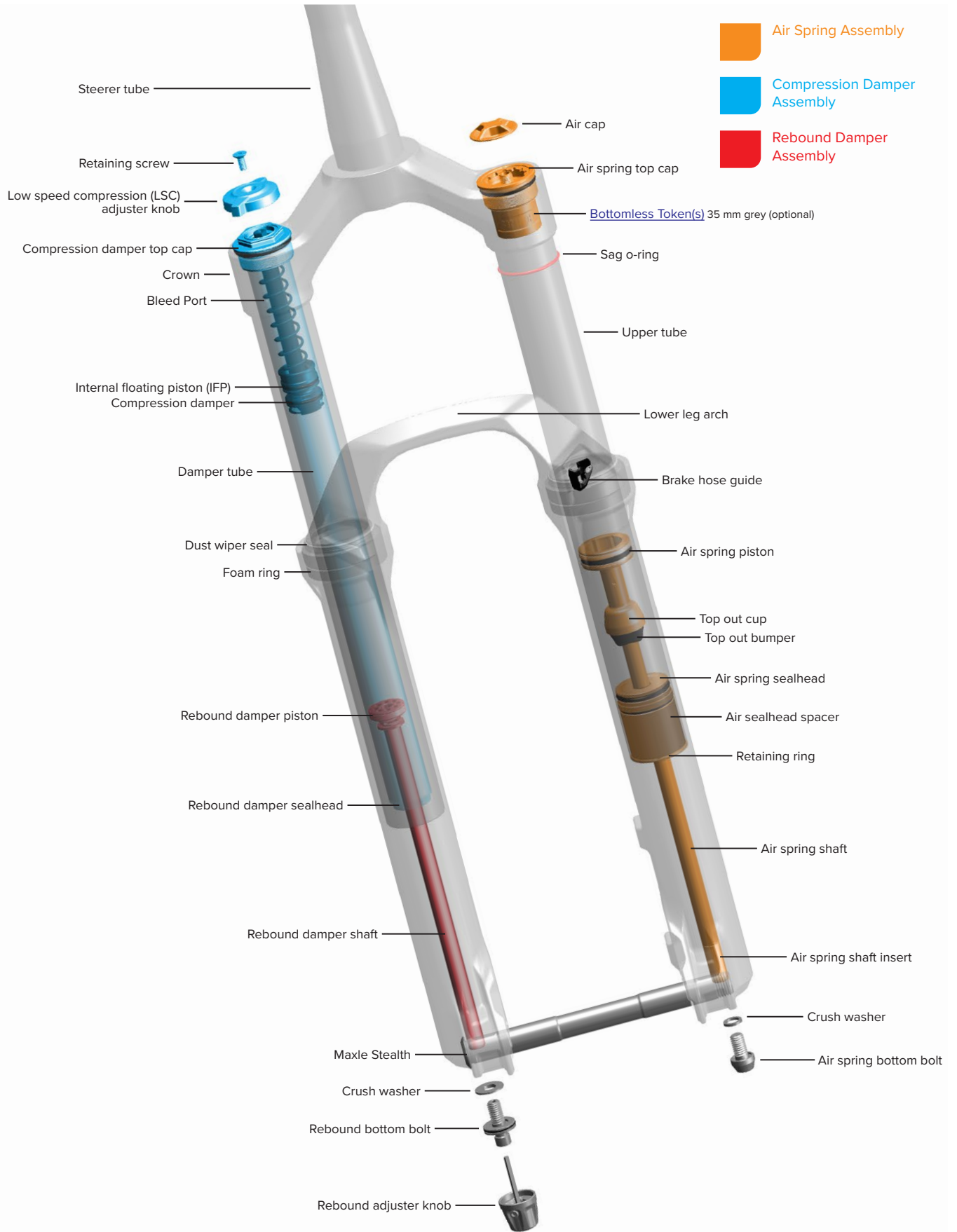

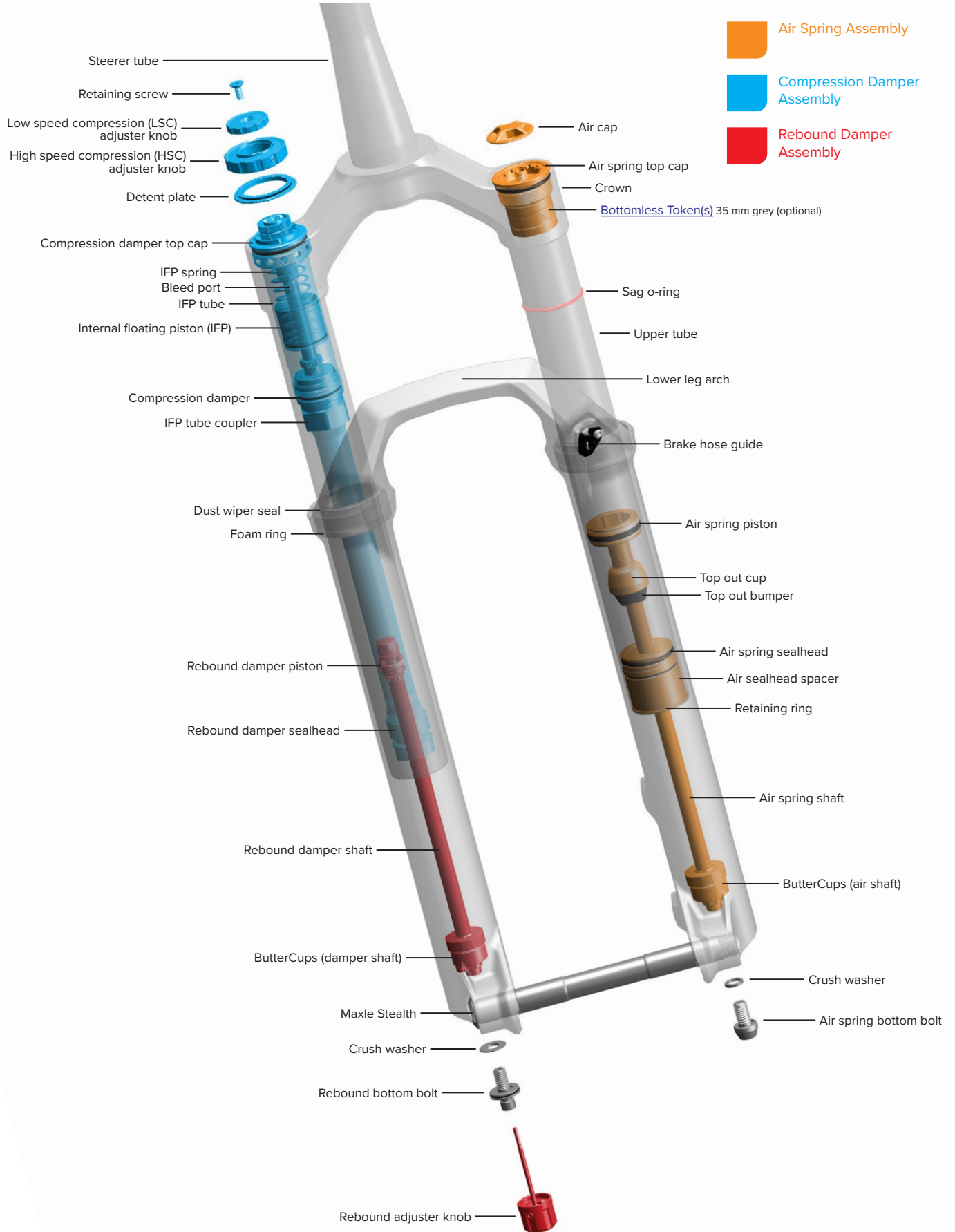

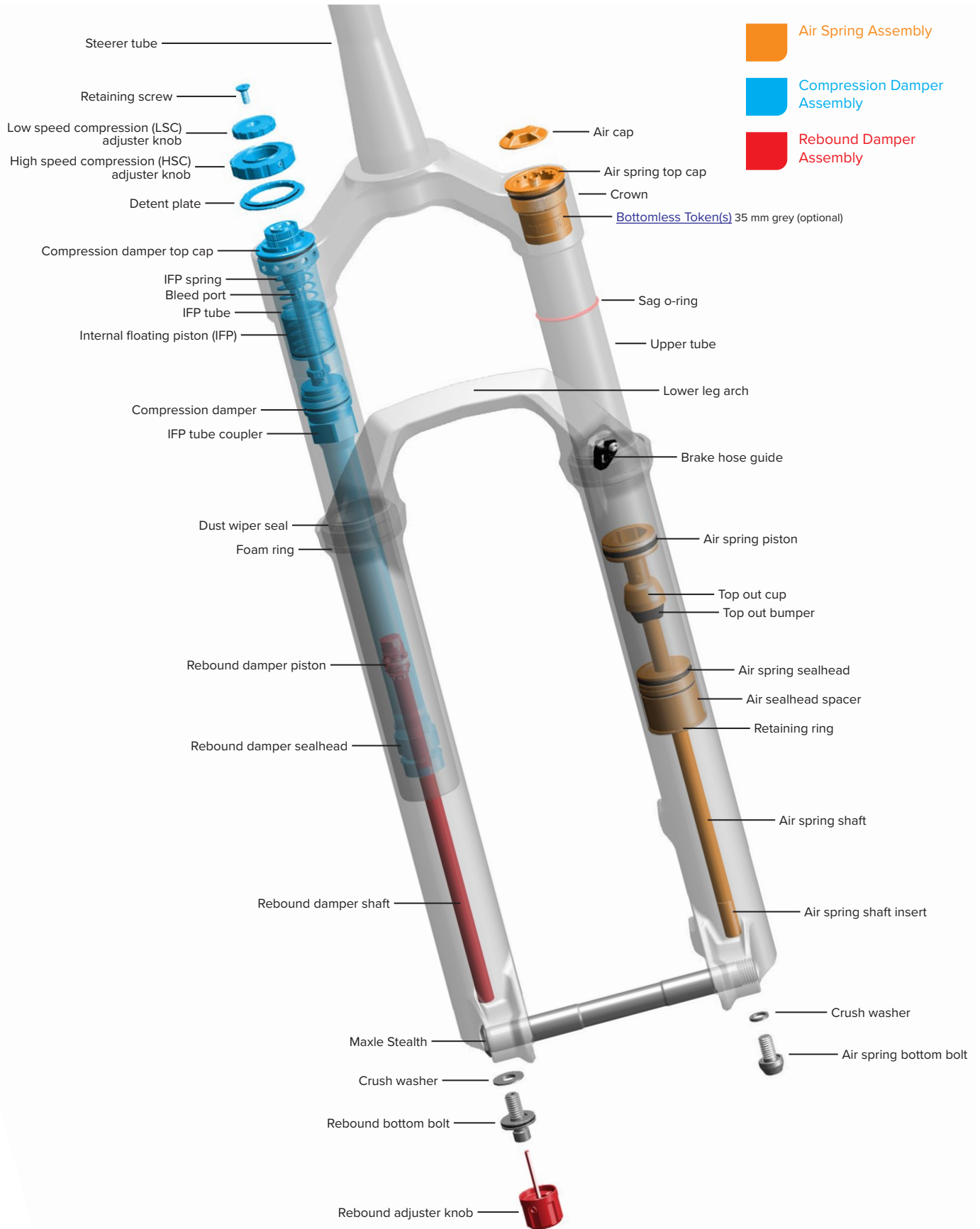

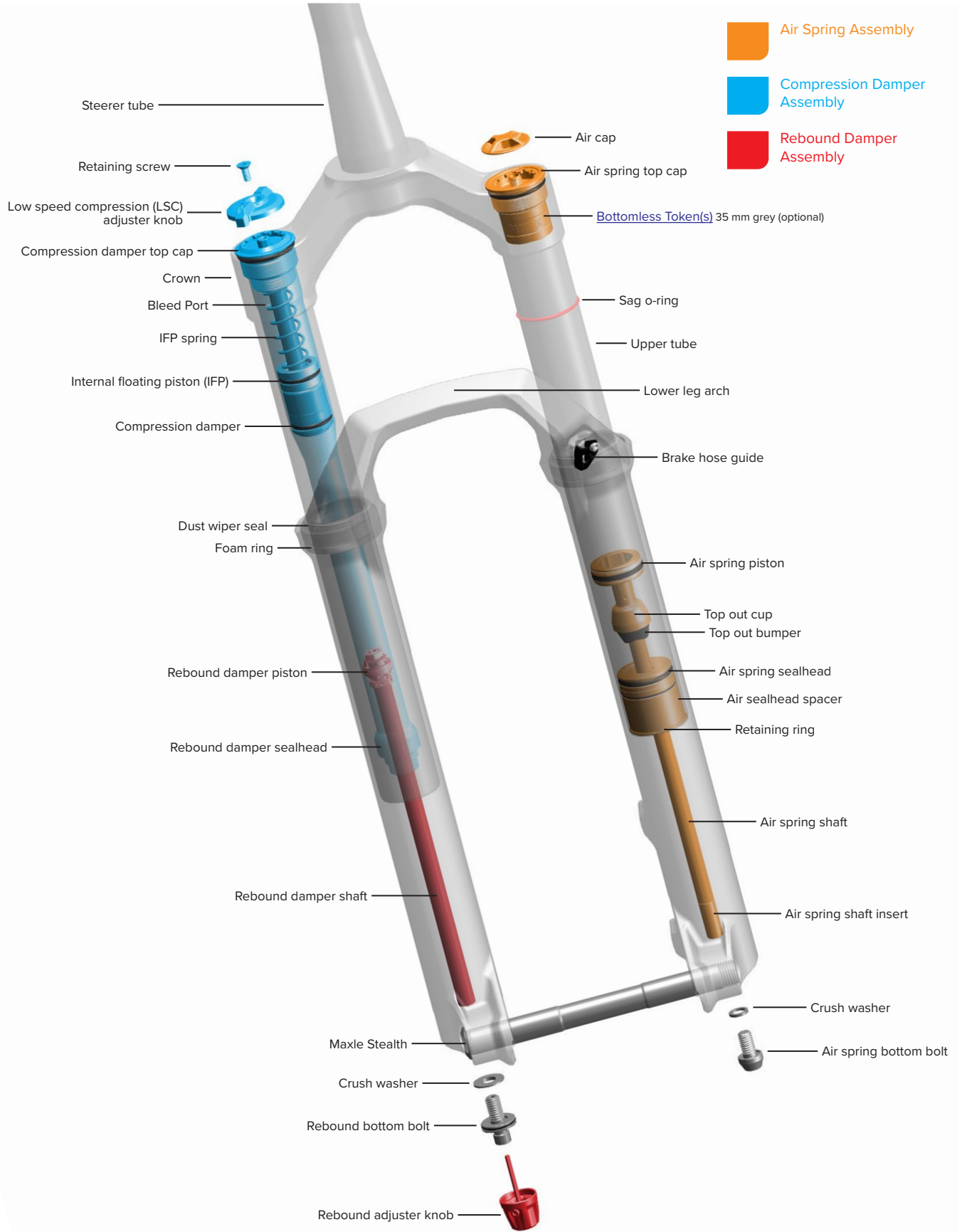

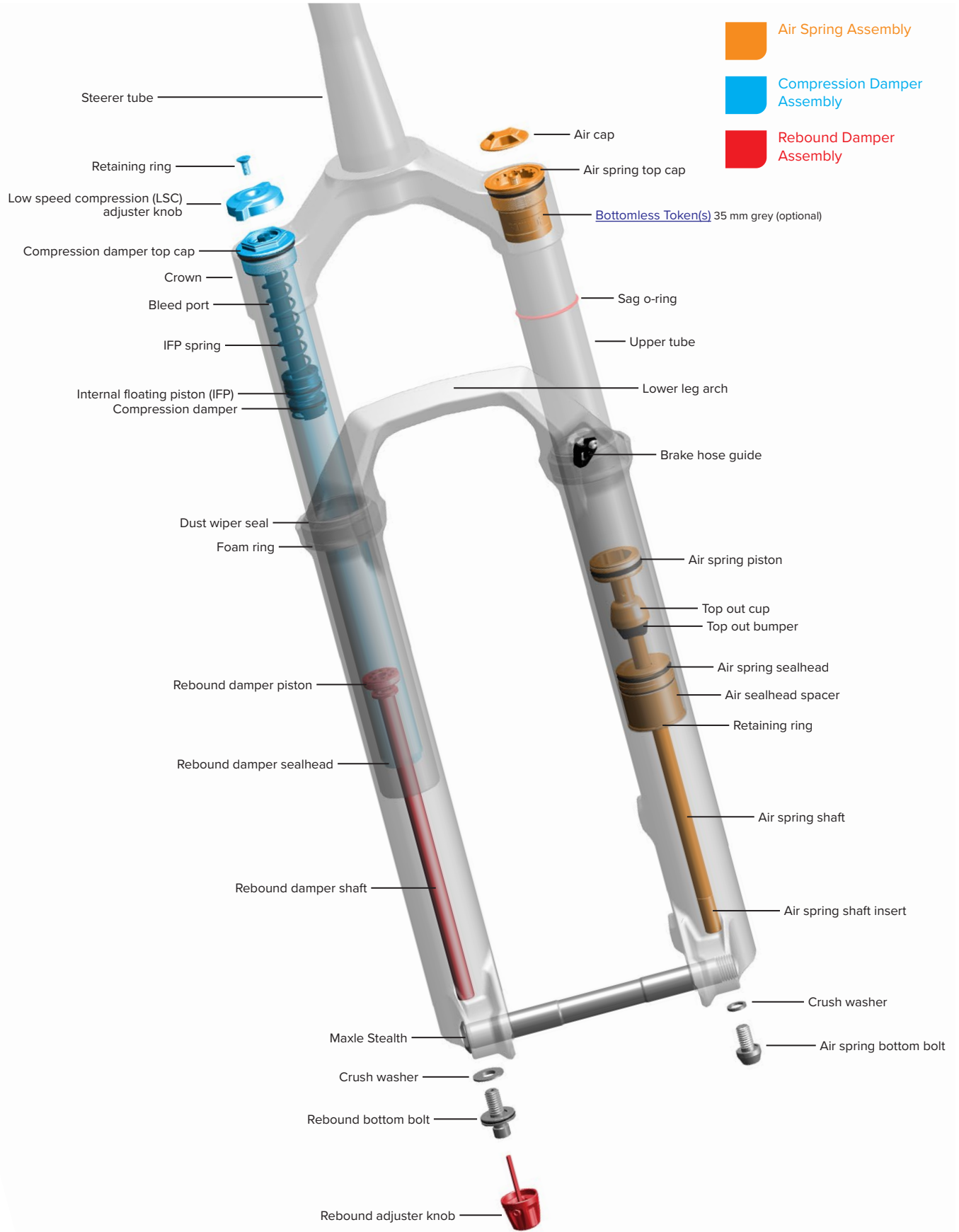

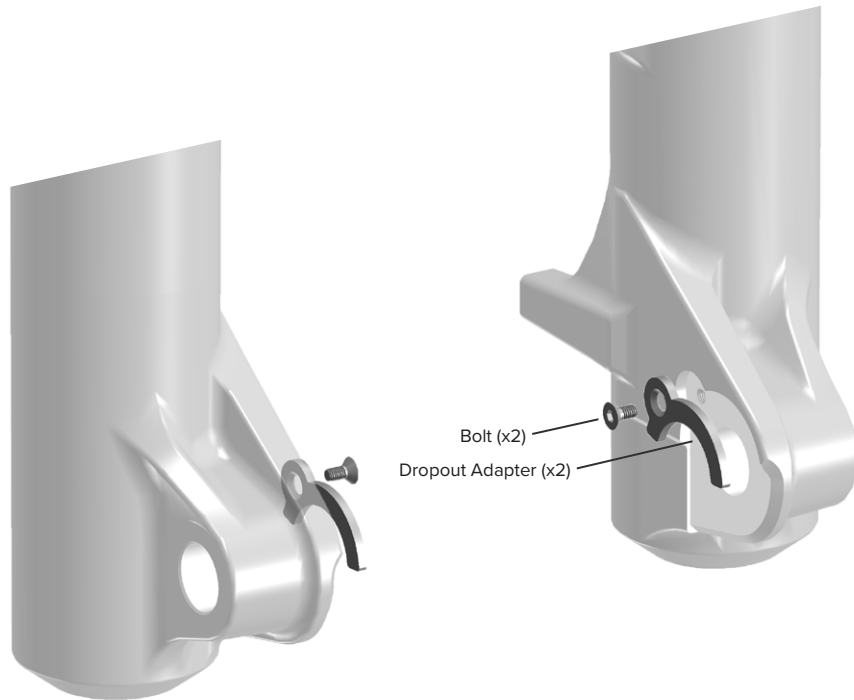
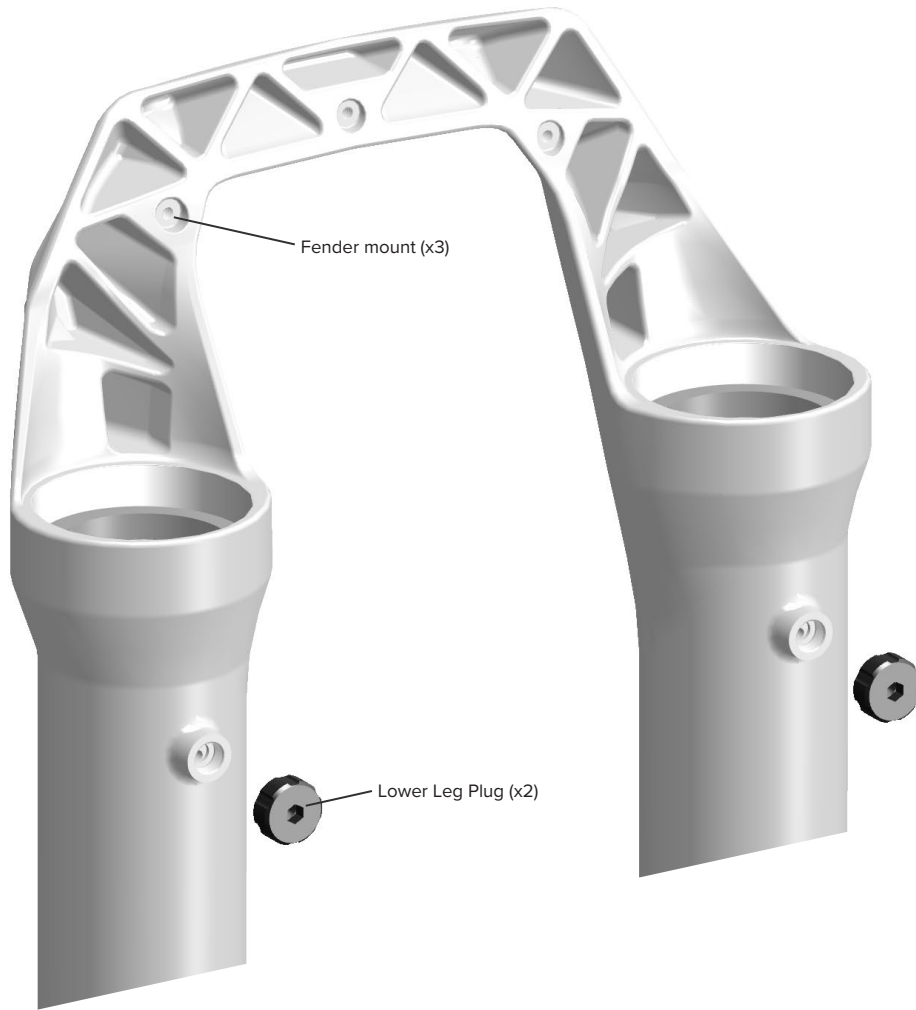



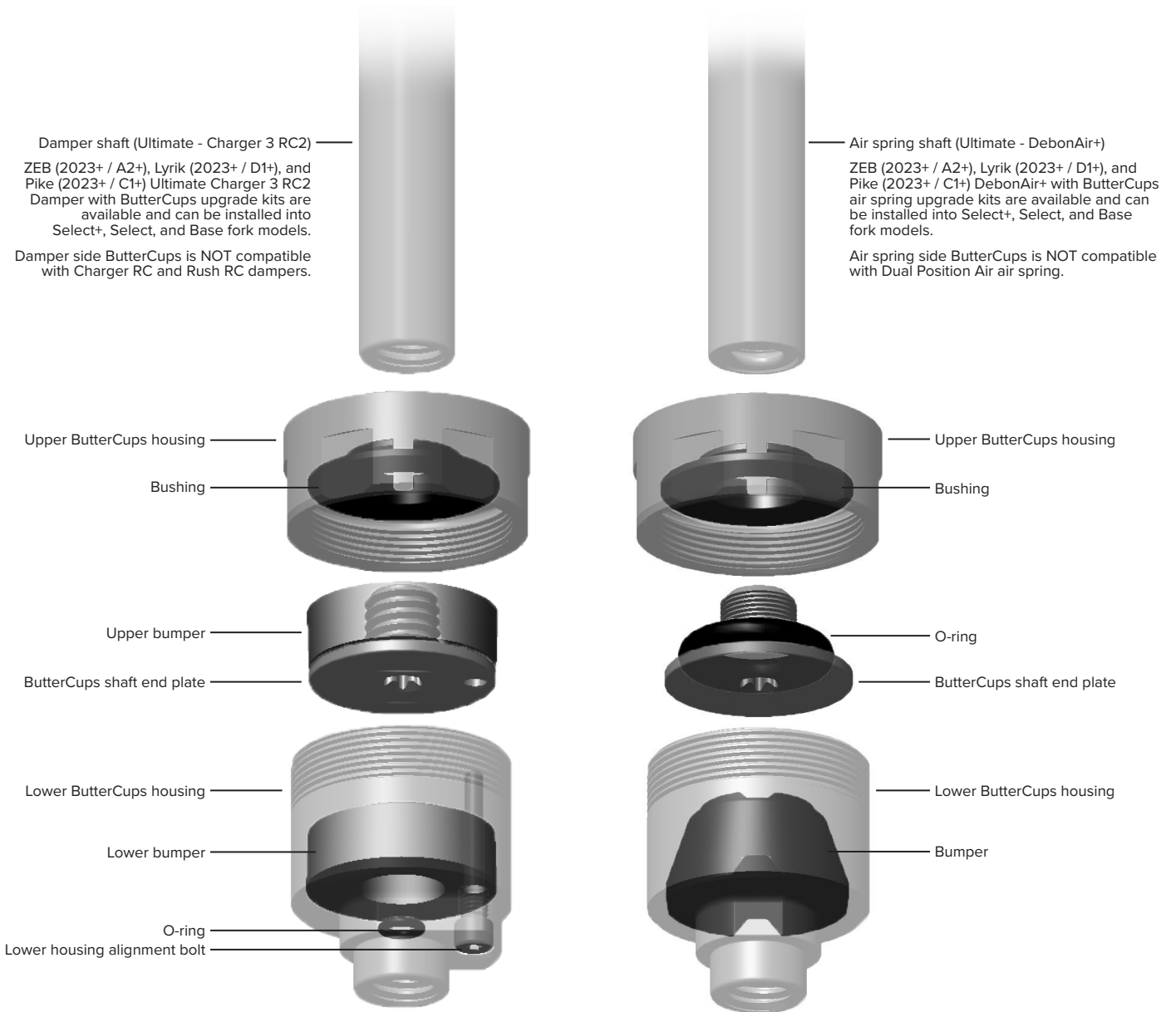

# Lower Leg Removal and Service

## 50/200 Hour Service Lower Leg Removal

ZEB is pictured in this section. Procedures are the same for Lyrik and Pike unless otherwise described.

- 1 Rotate the rebound adjuster knob counterclockwise until it stops. This is the full open/fast rebound setting.

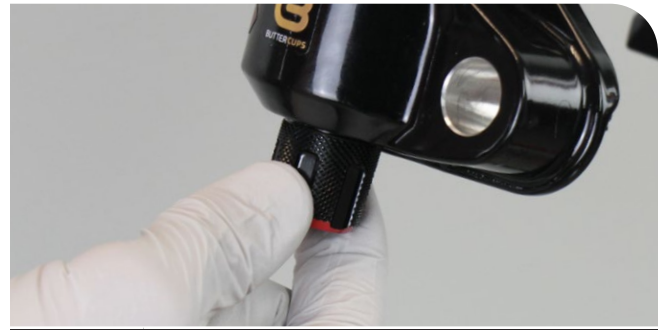

RC2

Counterclockwise - Full Open Setting



RC

Counterclockwise - Full Open Setting

- 2 Loosen the set screw and remove the rebound damper adjuster knob.



2.5 mm

RC2



2.5 mm

RC



**3 All DebonAir+ fork models:** Proceed to the next step.

**ZEB Dual Position Air (DPA):** Adjust and confirm the fork is in the **MAXIMUM** travel setting before the lower leg and the Dual Position Air spring top cap are removed.

Rotate the Dual Position Air adjuster knob to the **MAXIMUM** travel setting.

Position the fork vertically on the floor with a thin rubber mat under each end of the lower leg assembly. Compress the fork to at least 50% of full travel, then allow the fork to fully extend. Confirm the fork is set to its maximum travel setting (180 mm, 170 mm, or 160 mm) before proceeding.



Minimum travel setting



Maximum travel setting



Minimum travel setting



Maximum travel setting



Compress fork 75% travel

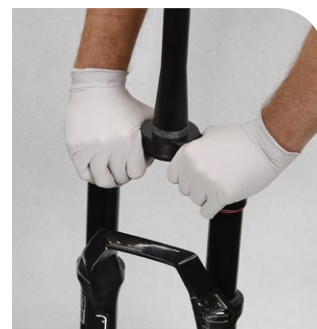

Release fork - full extension



Compress fork 50% travel



Release fork - full extension

**4** All fork models: Clamp the fork in a bicycle work stand vertically with the steerer tube oriented upward.

**⚠ WARNING - PRESSURIZED DEVICE**

To avoid possible SERIOUS INJURY OR DEATH, position the fork vertically with the steerer tube upward so the top cap is directed upward and away from you and others.



Bicycle work stand Dual Position Air



Bicycle work stand DebonAir+

**5** Remove the air valve cap.



ZEB Dual Position Air



ZEB, Lyrik, Pike DebonAir+

6

**⚠ WARNING - PRESSURIZED DEVICE**

Always wear certified safety glasses (ANSI Z87.1, EN166 EU).  
Verify all air pressure is removed from the suspension component. Failure to do so can result in **SERIOUS INJURY OR DEATH**. Refer to the Suspension Safety Precautions and Warnings section for detailed Pressurized Device warnings and instructions.

Perform the following air transfer and purge process to depressurize the positive and negative air spring chambers.

While holding the lower leg arch and pushing the lower leg down, depress the Schrader valve and slowly release air pressure. While depressing the Schrader valve, slowly allow the lower leg to compress while applying opposing pressure until you feel a sudden decrease in compressing resistance, then hold the lower leg in place to allow both air chambers to depressurize. As air transfers from the negative to the positive air chamber, air transfer should be heard.

While depressing the Schrader valve, push the lower leg down to extend the fork until there is no resistance and the fork can be fully extended. The negative air spring chamber is fully depressurized when the fork can fully be extended and no resistance is felt.

Repeat the process two to three times.



Pick or small hex wrench Dual Position Air

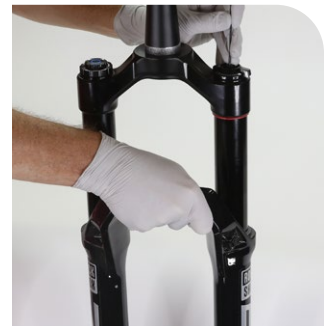

Pick or small hex wrench Dual Position Air



Pick or small hex wrench Dual Position Air



Pick or small hex wrench Dual Position Air



Pick or small hex wrench DebonAir+



Pick or small hex wrench DebonAir+



Pick or small hex wrench DebonAir+

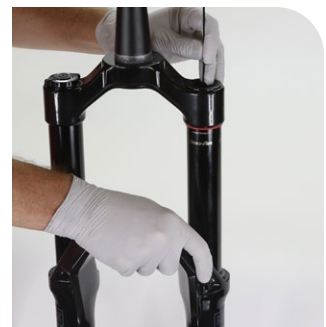

Pick or small hex wrench DebonAir+

**7** Remove the Schrader valve core from the top cap and set it aside.



**8** Compress and extend the fork to confirm the negative air chamber has been depressurized.

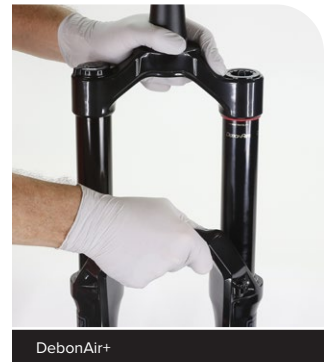
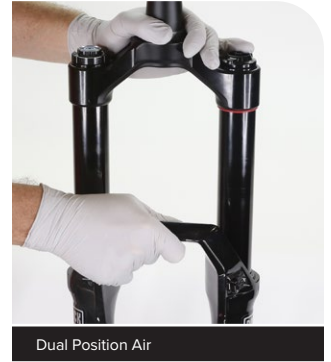



- 9 Place an oil pan under the fork to catch the draining oil.  
Loosen both bottom bolts 3 to 4 turns.

**CAUTION**

Place an oil pan on the floor underneath the product during service to catch any drained or spilled fluids. To avoid a slip and fall, and possible injury or harm, immediately clean any oil, fluid, grease, or lubricant from the floor in your work area.

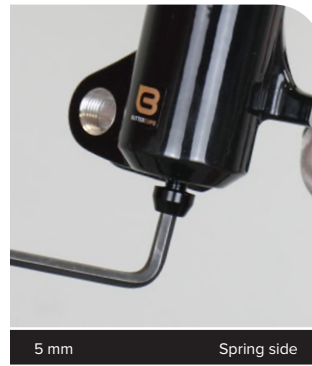

- 10 Strike each bolt head to dislodge the spring and damper shaft ButterCups from the lower leg. The bolt head should contact the bottom of the lower leg.  
Remove each bottom bolt. Clean each bolt and set them aside.

**NOTICE**

Do not strike the fork lower leg with mallet as this could damage the lower leg.

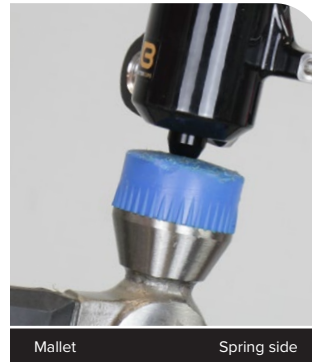

**Pike 27.5" and 29", Lyrik 29":** Insert a 5 mm hex wrench into the bolt, and tap the wrench to avoid damage to the lower leg.

### NOTICE

Do not strike the fork lower leg with mallet as this could damage the lower leg.

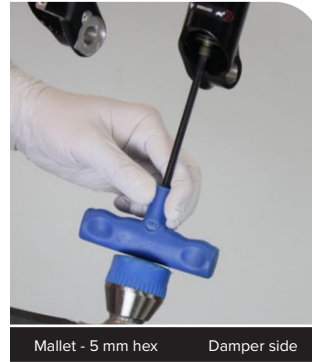
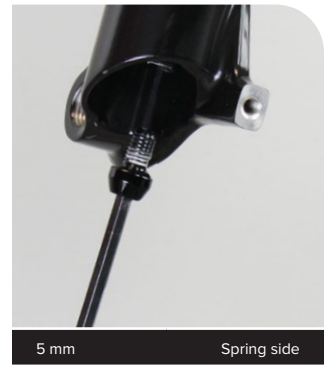
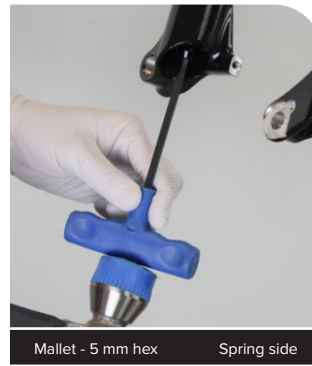

- 11** Firmly pull the lower leg downward until fluid begins to drain. Continue pulling downward to remove the lower leg.

*If the lower leg does not slide off of the upper tube or if oil does not drain from either side, the press fit of the shaft(s) into the lower leg may still be engaged. Reinstall the bottom bolts 2 to 3 turns and repeat the previous step.*

### NOTICE

Do not strike the fork arch with any tool when removing the lower leg as this could damage the lower leg.



**50 Hour Service** Continue the 50 Hour Service with [Lower Leg Service](#).

**200 Hour Service** Continue the 200 Hour Service with [Lower Leg Seal Service](#).

**TRAVEL CHANGE Ultimate, Select+, Select, Base:** For DebonAir+ air spring travel change, the original air spring assembly must be removed. Proceed to [Air Spring Removal](#).

**UPGRADE - DEBONAIR+ AIR SPRING WITH BUTTERCUPS Select+, Select, Base:** For DebonAir+ air spring replacement, the original air spring assembly must be removed. Proceed to [Air Spring Removal](#).

**UPGRADE - CHARGER 3 RC2 DAMPER WITH BUTTERCUPS Select+, Select, Base:** For damper replacement, the original damper assembly must be removed. Proceed to the appropriate Damper Service section for damper removal and installation procedures. Follow the applicable steps to remove the original damper and install the upgrade damper.

**Select+:** [Damper Service - Charger 3 RC2](#)

**Select:** [Damper Service - Charger RC](#)

**Base:** [Damper Service - Rush RC](#)



- 1 Remove the foam rings.



- 2 Clean the foam rings.  
Replace the foam rings if worn, damaged, or excessively contaminated.

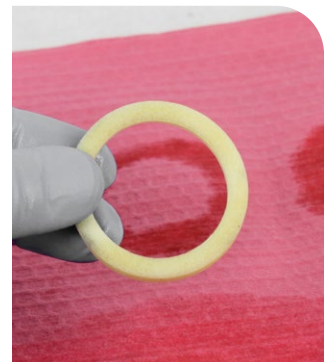
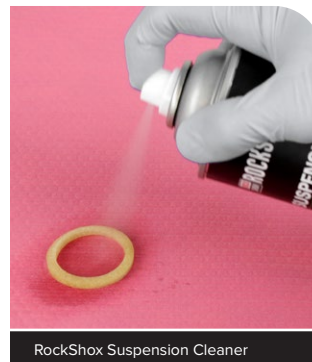

- 3 Soak the foam rings in Maxima PLUSH Dynamic Suspension Lube Light.

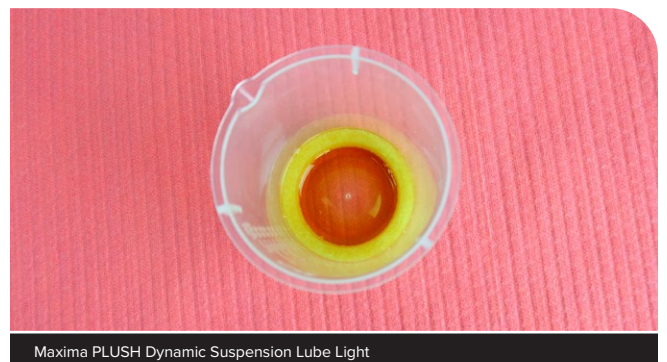

- 4** Clean the inside and outside of the lower leg.  
Clean the wiper seals.



RockShox Suspension Cleaner



Dowel



- 5** Install the foam rings under the wiper seals.  
Confirm the foam rings are installed evenly and square in the space under the wiper seals and do not protrude out of the groove.



 **50 Hour Service** Continue the 50 Hour Service with [Lower Leg Installation](#).

- 1 Remove and discard the foam rings.  
Remove the outer wire springs from the dust wiper seals.



Pick



- 2 Stabilize the lower leg on a bench top. Place the tip of a downhill tire lever under the wiper seal. Press down on the downhill tire lever handle to remove the seal.  
Repeat on the other side. Discard the wiper seals.

**NOTICE**

Keep the lower leg stable. Do not allow the lower leg to twist in opposite directions, compress toward each other, or be pulled apart. This will damage the lower leg.



Downhill tire lever



- 3 Clean the inside and outside of the lower leg.



RockShox Suspension Cleaner



Dowel

- 4** Soak new foam rings in Maxima PLUSH Dynamic Suspension Lube Light.

Install the new foam rings into the lower leg.

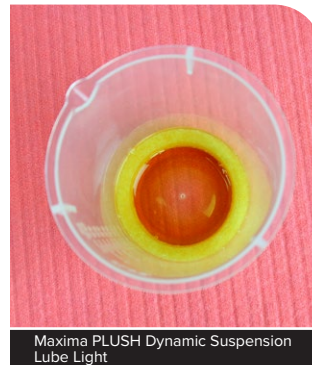

- 5** Remove the outer wire spring from each new dust wiper seal and set them aside.



- 6** Insert the narrow end of a new wiper seal into the recessed end of the RockShox Dust Seal Installation Tool.

**38 mm** - ZEB

**35 mm** - Lyrik and Pike

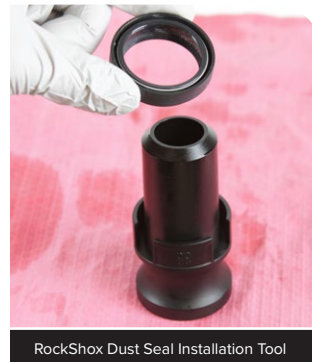

- 7** Stabilize the lower leg on a bench top. Hold the lower leg steady and press, or tap with a mallet, the wiper seal into the lower leg until the top of the seal is flush with the top of the lower leg.

Repeat on the other side.

### NOTICE

Only press, or tap with a mallet, the wiper seal into the lower leg until it is flush with the top surface of the lower leg. Pressing the wiper seal below the top surface of the lower leg will compress the foam ring.

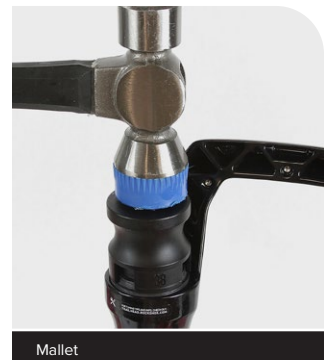



8 Install the outer wire springs.



**200 Hour Service** DebonAir+ - Air Spring Service: Continue with [Air Spring Service, Travel Change, and ButterCups Upgrade.](#)

**200 Hour Service** ZEB with Dual Position Air - Air Spring Service: Continue with [Dual Position Air \(DPA\) - ZEB - Air Spring Service.](#)

Procedures are the same for ZEB, Lyrik, and Pike unless otherwise pictured or described.

## 200 Hour Service Air Spring Removal

### NOTICE

Inspect each part for scratches. Do not scratch any sealing surfaces when servicing your suspension. Scratches can cause leaks.

When replacing seals and o-rings, use your fingers or a pick to remove the seal or o-ring. Spray RockShox Suspension Cleaner or isopropyl alcohol onto each part and clean with a clean lint-free shop towel.

Apply SRAM Butter grease to the new seals and o-rings.



SRAM Butter Grease

- 1 Clamp the fork in a bicycle work stand vertically with the steerer tube oriented upward.

### ⚠ WARNING - PRESSURIZED DEVICE

To avoid possible **SERIOUS INJURY OR DEATH**, position the fork vertically with the steerer tube upward so the top cap is directed upward and away from you and others.

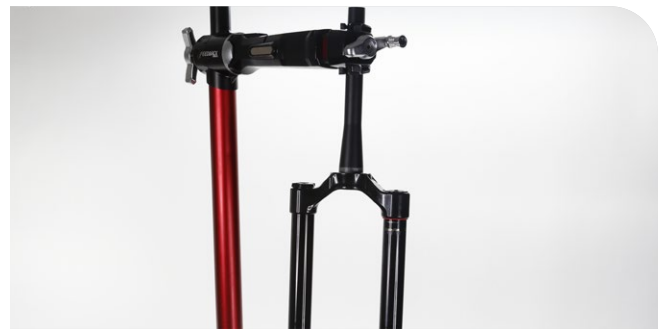

Bicycle work stand

- 2 Confirm the Schrader valve core is **NOT INSTALLED** in the air spring top cap before proceeding. Remove the Schrader valve core if installed.



DebonAir+



RockShox Schrader Valve Tool

DebonAir+

- 3** The positive and negative air spring chambers **must be FULLY depressurized** before removing the air spring top cap assembly.

Slowly compress and extend (push up/pull down) the air spring shaft to allow any remaining negative air pressure to bypass the air transfer dimple on the inside surface of the upper tube.

The negative air spring chamber is fully depressurized when the shaft can be pulled to full extension. When released, the air spring shaft will retract into the upper tube slightly due to pressure created when the air piston is extended past the air bypass dimple in the upper tube. This is normal.

Repeat the process two to three times.



**4** **⚠ WARNING - PRESSURIZED DEVICE**

Always wear certified safety glasses (ANSI Z87.1, EN166 EU).

Verify all air pressure is removed from the suspension component. Failure to do so can result in **SERIOUS INJURY OR DEATH**. Refer to the Suspension Safety Precautions and Warnings section for detailed Pressurized Device warnings and instructions.

Unthread and remove the air spring top cap. Press down firmly when loosening the top cap.

**NOTICE**

The fork top caps are tightened to a high torque value. Ensure the fork is held securely in the bicycle stand. To avoid damage to the top cap, press the top cap / cassette tool squarely and firmly down when loosening. Use a socket wrench with a long handle for extra leverage.

Clean the upper tube threads.

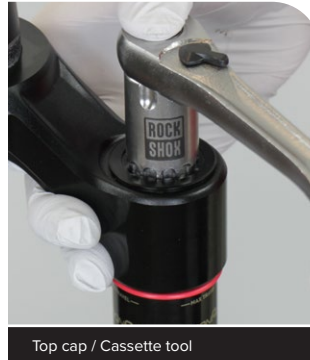

Top cap / Cassette tool



- 5** Remove the top cap o-ring and discard it.  
Apply grease to a new o-ring and install it.



**6 ZEB (Ultimate pictured):** Install a section of protective split plastic tube, or a shop towel, around the air spring shaft to protect the shaft surface during removal.

Remove the retaining ring.

**NOTICE**

Do not scratch the air spring shaft. Scratches can cause air to leak. Replace the air spring assembly if a scratch is visible.

Remove the split plastic tube or shop towel from the shaft.

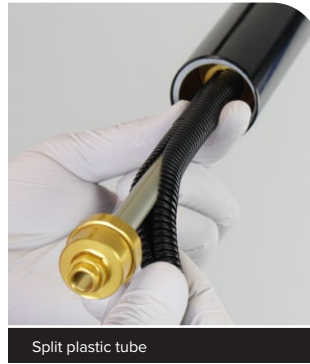

Split plastic tube

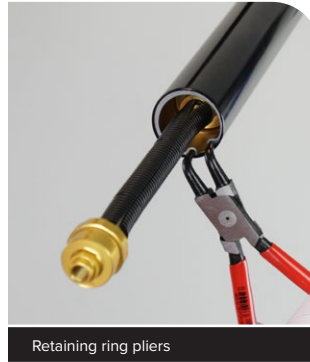

Retaining ring pliers

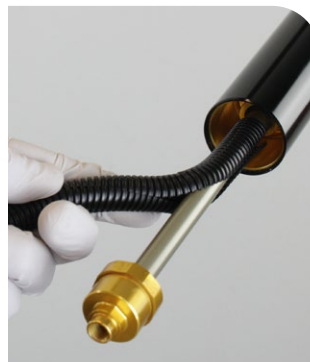
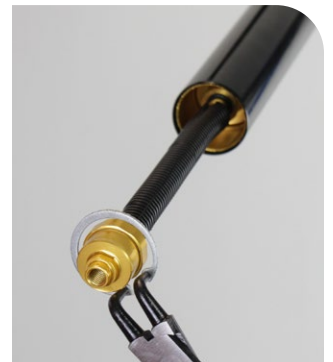
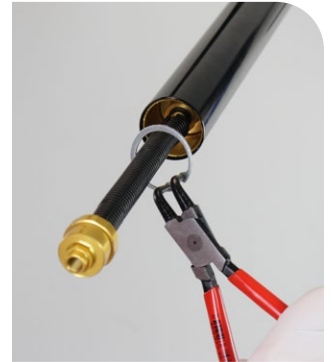



**Lyrik / Pike (Select+, Select, Base pictured):** Install a section of protective split plastic tube, or a shop towel, around the air spring shaft to protect the shaft surface during removal.

Remove the retaining ring.

**⚠ CAUTION**

Use care when working with sharp tools and parts. Never use sharp tools coated with oil and/or grease. Clean and remove all oil and/or grease from your hands and gloves, and tools before working with any sharp tool or part. Failure to do so can result in personal injury.

**NOTICE**

Do not scratch the air spring shaft. Scratches can cause air to leak. Replace the air spring assembly if a scratch is visible.

Remove the split plastic tube or shop towel from the shaft.

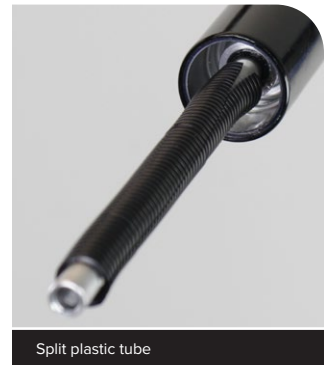

Split plastic tube

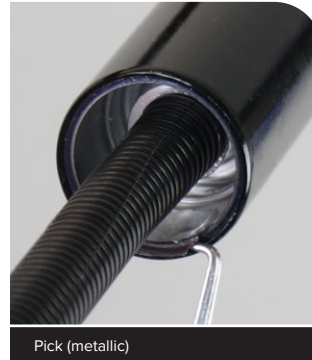

Pick (metallic)

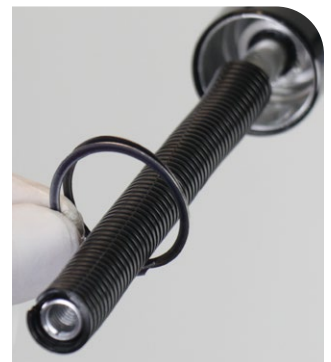
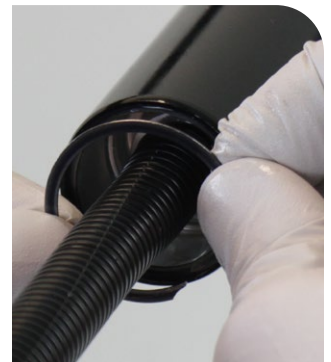
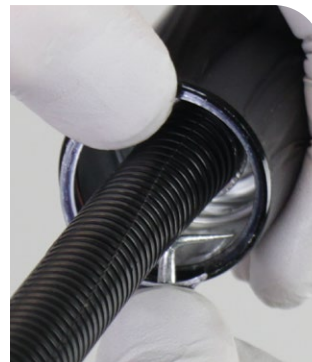
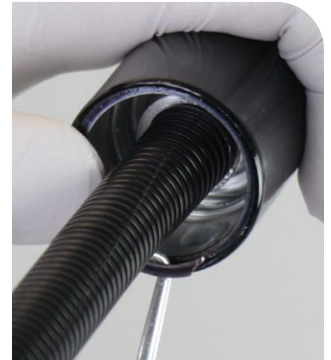

**7 Select+, Select, Base:** Thread a bottom bolt onto the shaft for added grip.

Push the shaft half way into the upper tube, then quickly and firmly pull the shaft out to dislodge the sealhead.

Remove the air spring assembly and sealhead spacer from the upper tube.

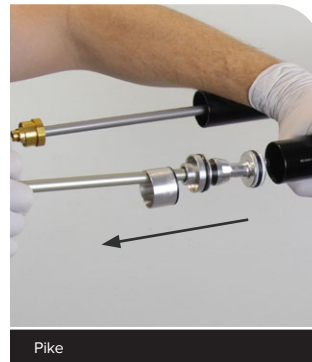
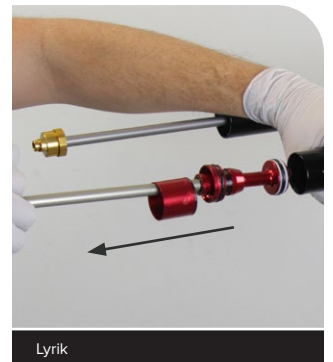
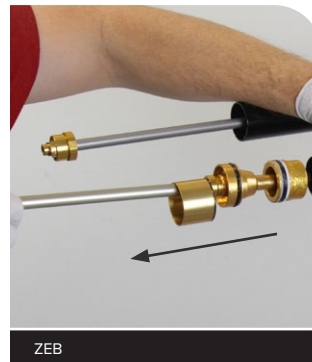
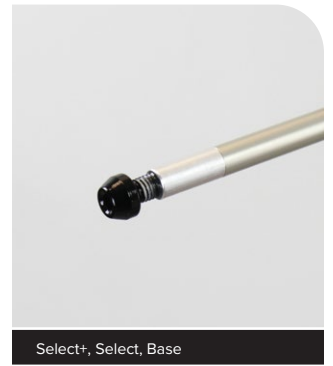
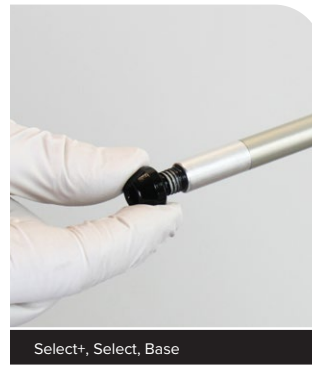

- 8 Clean the inside and outside of the upper tube.  
Inspect the inside and outside of the upper tube for damage.

### NOTICE

Scratches on the inside surface of the upper tube can cause air to leak. Replace the crown steerer upper tube assembly if a scratch is visible.



RockShox Suspension Cleaner



Dowel

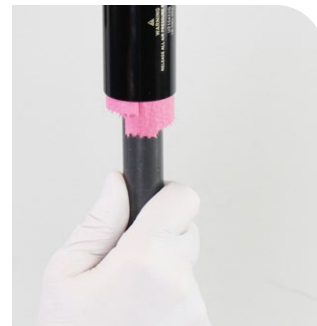

Dowel



RockShox Suspension Cleaner

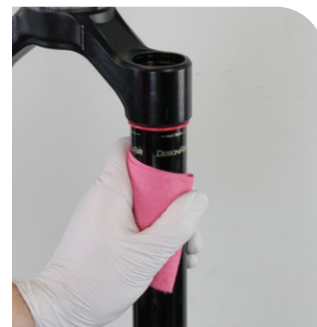

**200 Hour Service Ultimate - ButterCups Removal:** Continue with [ButterCups Removal - Air Spring Shaft - Ultimate](#).

**200 Hour Service Select+, Select, Base - Spring Service:** Continue with [DebonAir+ Air Spring Service](#).

**TRAVEL CHANGE Ultimate, Select+, Select, Base:** For DebonAir+ air spring travel change, proceed to the appropriate section listed below.

**Ultimate:** Proceed to [ButterCups Removal - Ultimate](#).

**Select+, Select, Base:** Proceed to [DebonAir+ Air Spring Travel Change \(optional\)](#).

**UPGRADE - DEBONAIR+ AIR SPRING WITH BUTTERCUPS Select+, Select, Base:** For DebonAir+ with ButterCups air spring replacement, proceed to [Air Spring Installation](#).

- 1 Clamp the lower ButterCups housing into a vise with Reverb Vise Blocks on the wrench flats, with the air spring oriented upward.  
Hold the air spring shaft for support and unthread the upper ButterCups housing (25 mm) from the lower ButterCups housing.



- 2 Remove the air spring assembly from the lower ButterCups housing and set it aside.



- 3 Remove the ButterCups bumper from the lower ButterCups housing and discard it.

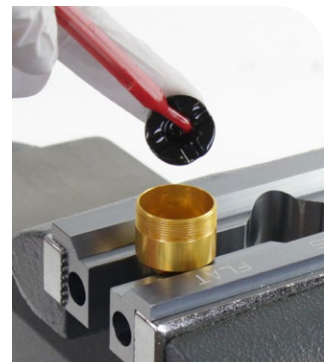

- 4 Remove the lower ButterCups housing from the vise. Clean the lower ButterCups housing.

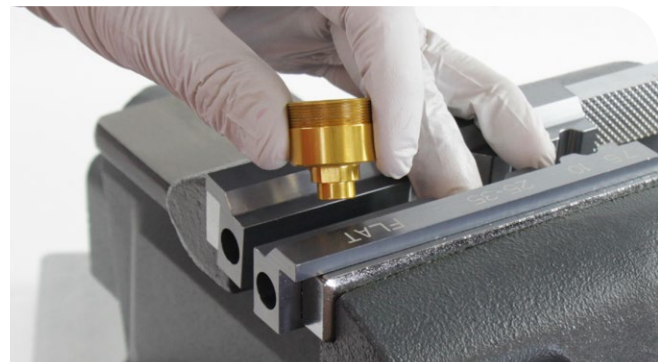

- 5** Clamp the air spring shaft, 12 mm - 15 mm below the end of the shaft, into the 10 mm slot of the Reverb Vise Blocks or RockShox Rear Shock Vise Block with the air piston oriented downward.

Clamp the air spring shaft only tight enough so it does not spin when the ButterCups shaft end plate is removed.

### NOTICE

Do not scratch the air spring shaft. Scratches can cause air to leak. Replace the air spring assembly if a scratch is visible.

Do not clamp the air spring shaft in the middle of the shaft. Clamping force will damage the air spring shaft. If the air spring shaft is damaged, the air spring assembly must be replaced.

Unthread and remove the ButterCups shaft end plate from the air spring shaft.



- 6** Remove the ButterCups shaft end plate o-ring (large) and discard it. The small o-ring does not need to be removed or replaced.



- 7** Remove the air spring shaft from the vise and vise blocks. Remove the upper ButterCups housing and bushing assembly from the air spring shaft and set it aside.

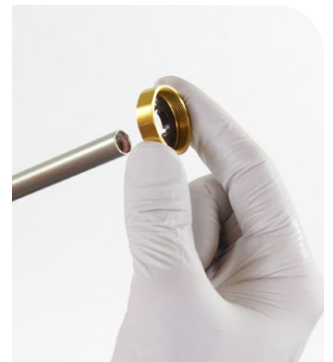
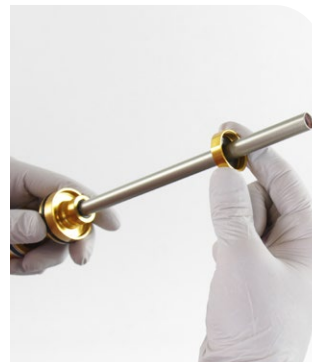

**200 Hour Service** Ultimate, Select+, Select, Base: Continue with [DebonAir+ Air Spring Service](#).

**TRAVEL CHANGE** Ultimate: Continue with [DebonAir+ Air Spring Travel Change \(optional\)](#).



## DebonAir+ Air Spring Travel Change (optional)

Maximum fork travel can be changed by replacing the stock air spring shaft/piston assembly with a shorter or longer air spring shaft/piston assembly. If maximum travel is increased or reduced, a longer or shorter air spring shaft/piston assembly must be installed. For example, to change travel on a fork with a maximum of 140 mm of travel to a maximum of 160 mm of travel, a 160 mm air spring shaft/piston assembly must be installed.

**Travel Change - Select+, Select, Base:** The [air spring shaft insert must be removed](#) from the original air spring shaft and installed into the longer or shorter air spring shaft.

**Travel Change - Ultimate:** The [ButterCups assembly must be removed](#) from the original air spring shaft/piston assembly and installed into the longer or shorter travel change replacement air spring shaft/piston assembly. Continue to step 2 below.

It may also be necessary to add or remove Bottomless Tokens if travel is changed. Refer to [Air Spring Travel Change and Bottomless Tokens](#) for details.

Refer to the *RockShox Spare Parts Catalog* at [www.sram.com/service](http://www.sram.com/service) for available air spring travel change and ButterCups damper and air spring Upgrade kits. For part ordering information, please contact your local SRAM distributor or dealer.

**1 Select+, Select, Base only:** To change travel, the air spring shaft insert must be removed.

Clamp the air spring shaft, 12 mm - 15 mm below the end of the shaft, into the 10 mm slot of the Reverb Vise Blocks or RockShox Rear Shock Vise Block with the air piston oriented downward.

Clamp the air spring shaft only tight enough so it does not spin when the air spring shaft insert is removed.

Unthread and remove the air spring shaft insert from the air spring shaft and set it aside. Remove the air spring shaft from the vise.

Remove the o-ring and discard it. Apply grease to a new o-ring and install it.

### NOTICE

Do not scratch the air spring shaft. Scratches can cause air to leak. Replace the air spring assembly if a scratch is visible.

Do not clamp the air spring shaft in the middle of the shaft. Clamping force will damage the air spring shaft. If the air spring shaft is damaged, the air spring assembly must be replaced.

**TRAVEL CHANGE:** The air spring shaft insert will be installed into the new longer or shorter air spring shaft. Proceed to step 2.

**2** Remove the air sealhead assembly and top out bumper from the air spring shaft.

Clean the top out bumper.

Set the sealhead assembly aside.

*If the fork requires service, discard the sealhead assembly and install a new sealhead assembly in Step 7 (200 Hour Service Kit required). Go to [Air Spring Service](#) for complete service procedures.*

**Ultimate:** Proceed to step 4.

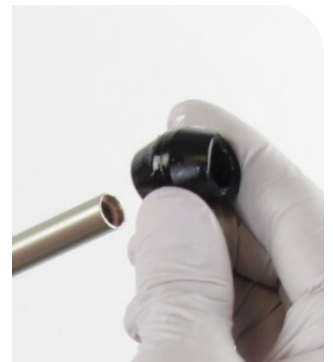
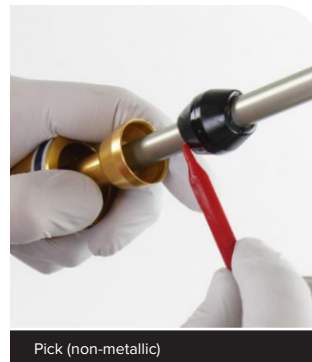
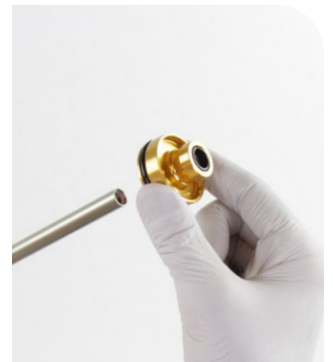
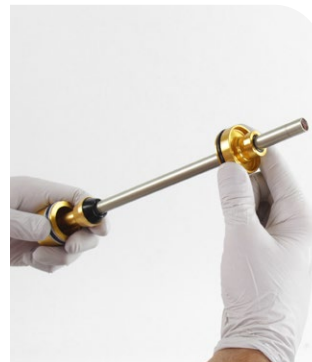
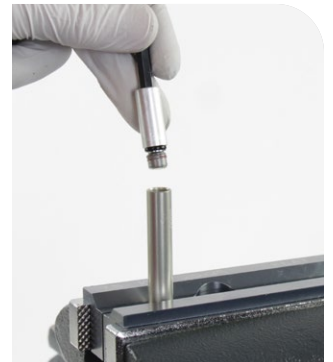

Pick (non-metallic)

- 3 Select+, Select, Base only:** Clamp the new (longer or shorter) air spring shaft into the 10 mm slot of the Reverb Vise Blocks or RockShox Rear Shock Vise Block with the air piston oriented downward.

Clamp the air spring shaft only tight enough so it does not spin when the air spring shaft insert is removed.

Apply Threadlocker Loctite 2760 (red) or equivalent to 2 to 3 threads on the air spring shaft insert.

Install the insert into the shaft and tighten it.

Remove the air spring shaft from the vise.

**⚠ WARNING - CRASH HAZARD**

To avoid separation of parts, threadlocker must be applied as instructed. Failure to apply threadlocker could result in separation of the parts, and possible **SERIOUS INJURY OR DEATH**.

**⚠ WARNING - CRASH HAZARD**

Parts must be tightened to the specified torque. Failure to do so can result in **SERIOUS INJURY OR DEATH**.

**NOTICE**

Do not scratch the air spring shaft. Scratches can cause air to leak. Replace the air spring assembly if a scratch is visible.

- 4** Apply grease to the quad ring seal and air piston.

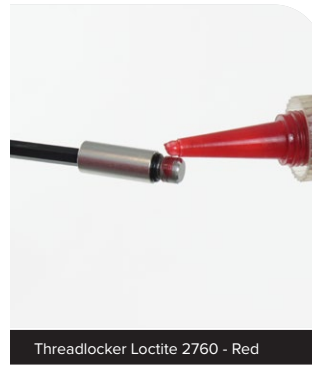

Threadlocker Loctite 2760 - Red

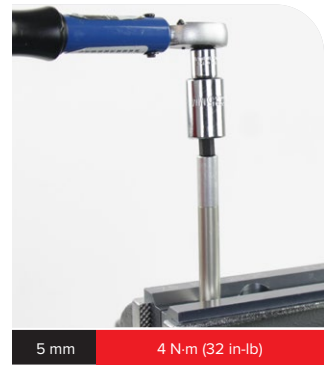

5 mm

4 N-m (32 in-lb)

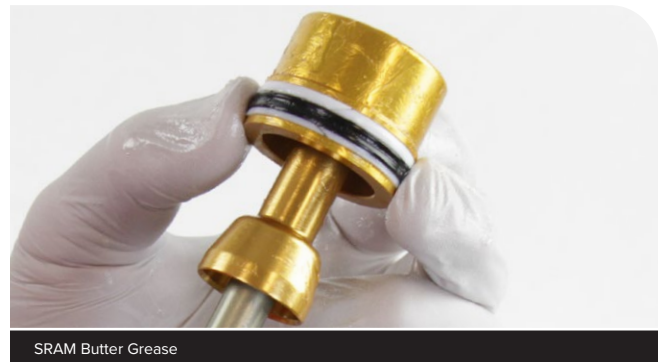

SRAM Butter Grease

- 5** Apply a liberal amount of grease to the air spring shaft.



SRAM Butter Grease



- 6 Apply a thin layer of grease to the top out bumper and install it onto the air spring shaft.



- 7 Apply grease to the inner and outer seals on the sealhead.

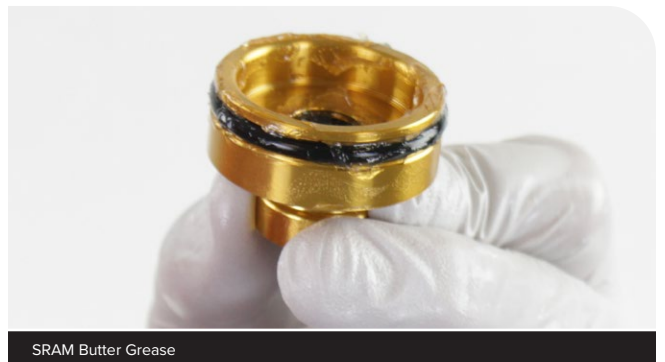
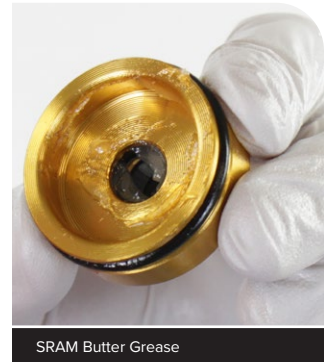
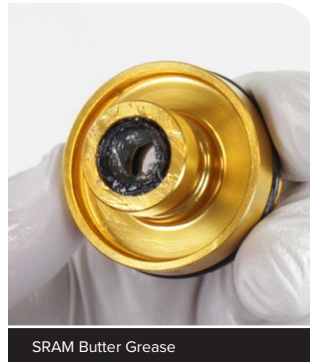

**8** Install the sealhead assembly onto the air shaft, flat side first.



**9** Remove the grease from the shaft (Ultimate) or shaft insert (Select+, Select, Base) inner threads.

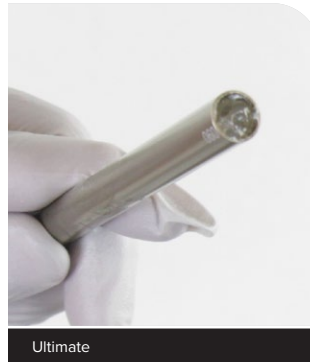

**TRAVEL CHANGE** **Select+, Select, Base:** For travel change only, proceed to [Air Spring Installation](#).

**TRAVEL CHANGE** **Ultimate:** For travel change only, proceed to [ButterCups Installation](#).

## DebonAir+ Bottomless Tokens

Bottomless Tokens can be added to, or removed from the DebonAir+ top cap to fine-tune the bottom-out feel and spring curve. Use the table below to help determine the number of Bottomless Tokens that can be used with each maximum fork travel option. If fork travel is changed from stock, it may be necessary to add or remove Bottomless Tokens.

Refer to the *RockShox Suspension Tuning and Setup Guide* for more details. Refer to the *RockShox Spare Parts Catalog* at [www.sram.com/service](http://www.sram.com/service) for available air spring and Bottomless Token kits. For part ordering information, please contact your local SRAM distributor or dealer.

### ZEB - 27.5" Boost & 29" Boost

Fork Travel (mm)	Bottomless Tokens (grey) Factory Installed	Bottomless Tokens (grey) Maximum
190	0	4
180	0	4
170	1	4
160	1	5
150	2	5

### Lyrik - 27.5" Boost & 29" Boost

Fork Travel (mm)	Bottomless Tokens (grey) Factory Installed	Bottomless Tokens (grey) Maximum
160	0	5
150	0	5
140	1	5

### Pike - 27.5" Boost & 29" Boost

Fork Travel (mm)	Bottomless Tokens (grey) Factory Installed	Bottomless Tokens (grey) Maximum
140	0	5
130	0	6
120	1	6

## DebonAir+ Bottomless Tokens Installation (optional)

Bottomless Tokens reduce air volume in your fork and create greater ramp at the end of the fork travel. Add or remove Tokens to tune your fork's bottomless feel. Do not install more than the maximum number of Bottomless Tokens for your fork.

Install Bottomless Token(s) onto the air spring top cap, as desired. Thread a Bottomless Token into another Bottomless Token, and/or into the bottom of the top cap, and tighten.



8 mm

4 N·m (32 in-lb)

Top cap / Cassette tool

A ZEB Ultimate air spring assembly is pictured in this section. Procedures are the same for ZEB, Lyrik, and Pike unless otherwise pictured or described.

- 1 Remove the air sealhead assembly and top out bumper from the air spring shaft.

Discard the sealhead assembly.

Clean the top out bumper.

Clean and inspect the air spring shaft for damage.

**NOTICE**

Scratches can cause air to leak. Replace the air spring assembly if a scratch is visible.

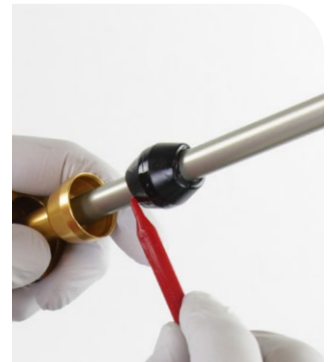
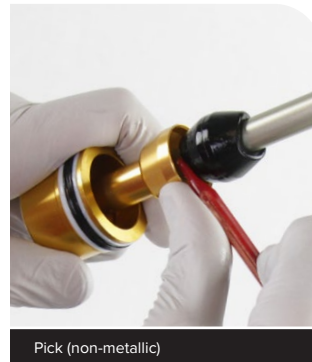
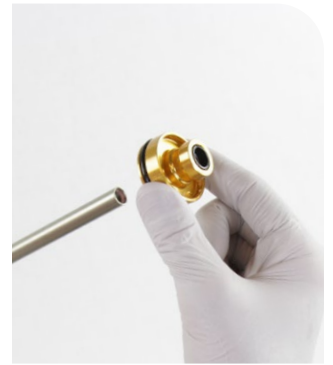
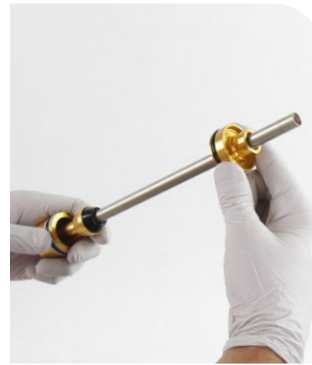

Pick (non-metallic)



- 2** Remove the glide ring (upper), quad ring, and backup ring (lower) from the air piston and discard them.

**NOTICE**

Do not scratch the air piston. Scratches will cause air to leak. Replace the air spring assembly if a scratch is visible.

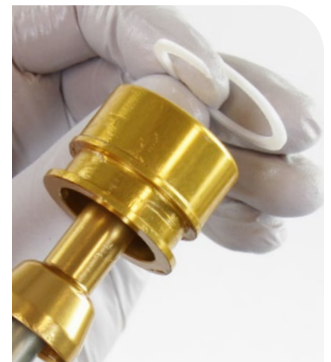
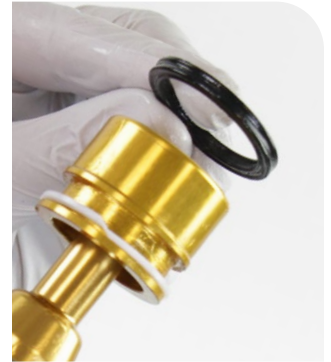
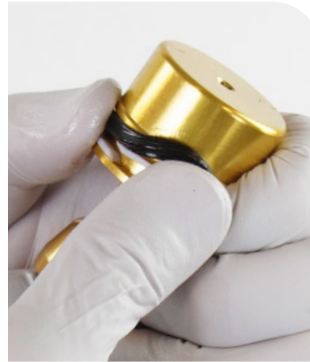
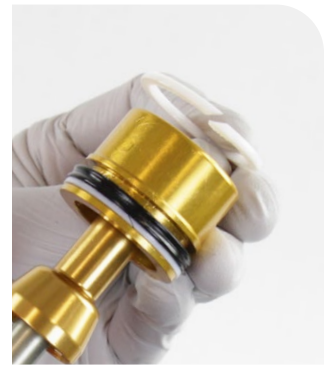
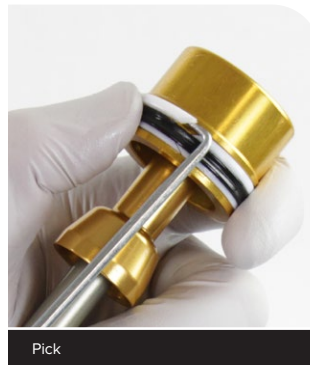

- 3** Clean the air piston.

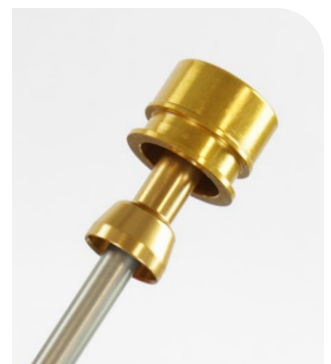
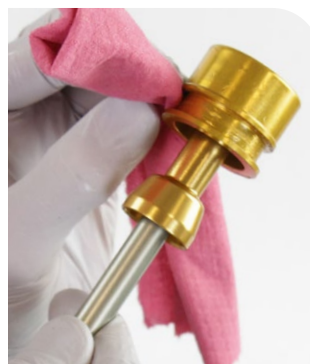

- 4** Install a new backup ring (thin, lower) onto the air piston.  
Apply grease to the new quad ring seal and install it onto the air piston above the backup ring.  
Install a new glide ring (thick, upper) tapered end upward, above the quad ring seal.

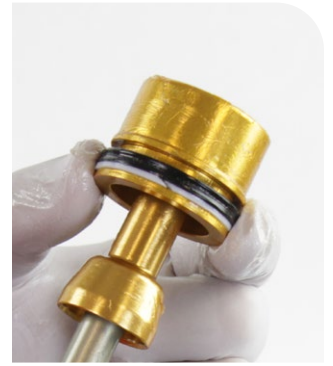

- 5** Apply a liberal amount of grease to the air spring shaft.



SRAM Butter Grease

- 6** Apply a thin layer of grease to the new top out bumper and install it onto the air spring shaft.



SRAM Butter Grease



**7** Apply grease to the inner and outer seals on the **new** sealhead.

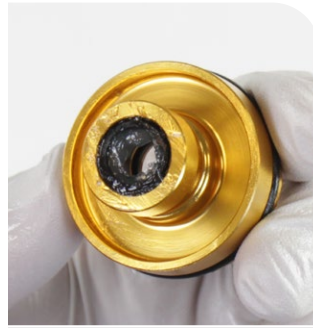

SRAM Butter Grease



SRAM Butter Grease



SRAM Butter Grease

**8** Install the new sealhead assembly onto the air shaft, flat side first.





9 Remove the grease from the inner shaft threads.

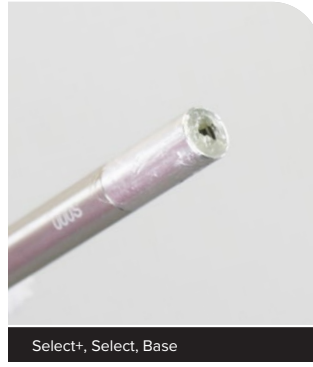
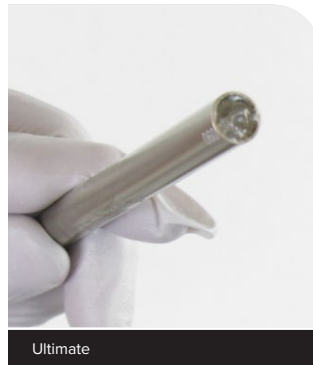

Refer to the *RockShox Spare Parts Catalog* at [www.sram.com/service](http://www.sram.com/service) for available DebonAir+ Air Spring with ButterCups upgrade kits. For part ordering information, please contact your local SRAM distributor or dealer.

The DebonAir+ air spring shaft ButterCups assembly is NOT compatible with Dual Position Air. Do not install a DebonAir+ air spring shaft ButterCups assembly onto a Dual Position Air air spring shaft.

The DebonAir+ air spring shaft ButterCups assembly is NOT compatible with a DebonAir+ air spring shaft with a shaft insert installed (Select+, Select, Base). Do not install a DebonAir+ air spring shaft ButterCups assembly onto a DebonAir+ air spring shaft if a shaft insert is installed. [Remove the shaft insert](#) before installing a DebonAir+ ButterCups assembly.

- 1 Install the ButterCups upper housing and bushing assembly onto the air spring shaft.



- 2 Apply grease to a new o-ring and install it onto the ButterCups shaft end plate, over the threads.

Clean all grease from the threads.

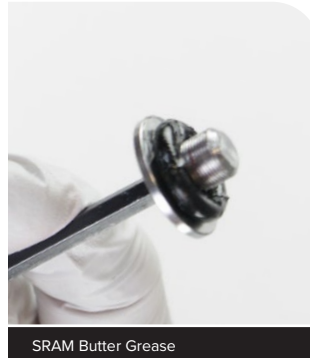

SRAM Butter Grease

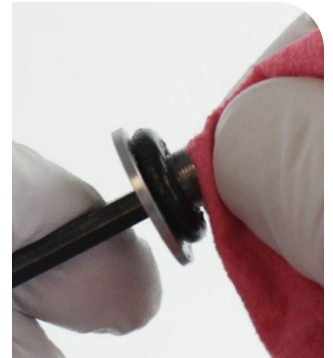

- 3 Apply Loctite Threadlocker 2760 (red), or equivalent, to the first two to three full threads of the ButterCups shaft end plate.

#### **⚠ WARNING - CRASH HAZARD**

To avoid separation of parts, threadlocker must be applied as instructed. Failure to apply threadlocker could result in separation of the parts, and possible **SERIOUS INJURY OR DEATH**.



Threadlocker Loctite 2760 - Red



- 4** Position the upper ButterCups housing above the vise blocks.  
Clamp the air shaft into the 10 mm slot of the Reverb Vise Blocks or RockShox Rear Shock Vise Block.

Clamp the air shaft only tight enough so it does not spin when the ButterCups is tightened.

**⚠ WARNING - CRASH HAZARD**

Parts must be tightened to the specified torque. Failure to do so can result in **SERIOUS INJURY OR DEATH**.

**NOTICE**

Scratches can cause air to leak. Replace the air spring assembly if a scratch is visible.

Do not clamp the air spring shaft in the middle of the shaft. Clamping force will damage the air spring shaft. If the air spring shaft is damaged, the air spring assembly must be replaced.

Thread the ButterCups shaft end plate into the air shaft and tighten it.



- 5** Apply Loctite Threadlocker Blue 242 (blue), or equivalent, to three full outer threads on the lower ButterCups housing.

**⚠ WARNING - CRASH HAZARD**

To avoid separation of parts, threadlocker must be applied as instructed. Failure to apply threadlocker could result in separation of the parts, and possible **SERIOUS INJURY OR DEATH**.

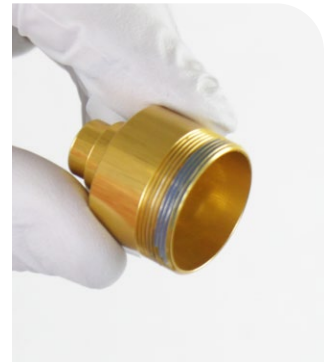
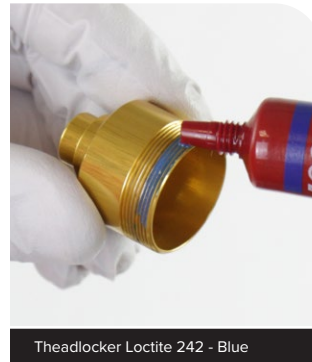

- 6** Install a new ButterCups bumper into the lower ButterCups housing, wide end first.

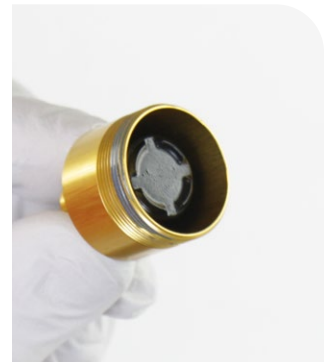

- 7** Position the lower ButterCups housing and bumper onto the ButterCups end plate.

Slide the upper ButterCups housing and bushing assembly up and thread it onto the lower ButterCups housing finger tight.

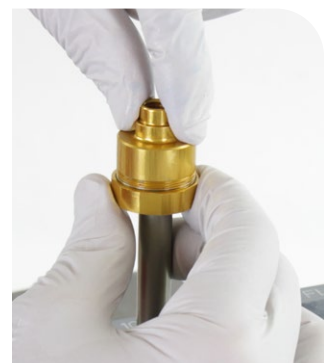

8 Remove the air shaft from the vise and vise blocks.

Clamp the lower ButterCups housing into a vise with Reverb Vise Blocks on the wrench flats, air spring piston oriented upward.

Tighten the upper ButterCups housing onto the lower housing.

**⚠ WARNING - CRASH HAZARD**

Parts must be tightened to the specified torque. Failure to do so can result in SERIOUS INJURY OR DEATH.



**TRAVEL CHANGE Ultimate:** For travel change only, proceed to [Air Spring Installation](#).

**Upgrade DebonAir+ Air Spring with ButterCups (Select+, Select, and Base):** Follow the procedures below to install an optional DebonAir+ Air Spring assembly with ButterCups Upgrade Kit.

- 1 Apply a liberal amount of SRAM Butter grease evenly around the end of a clean plastic dowel, approximately 150 mm from one end. Use the dowel to apply the grease to the inside surface of the upper tube, approximately 150 mm into the tube.

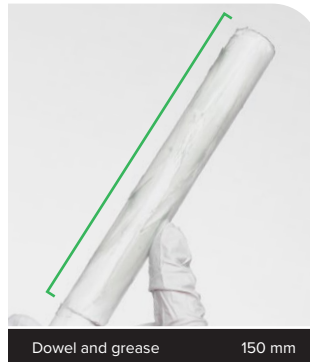

- 2 Apply grease to the air piston and sealhead outer o-rings.



- 3 **Upgrade only - DebonAir+ Air Spring with ButterCups:** Apply grease to the NEW air spring shaft above and below the sealhead. Slide the sealhead and top out bumper up and down to spread the grease and lubricate the seals.

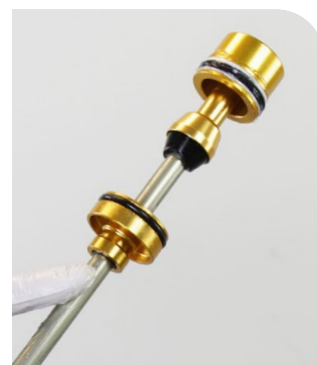
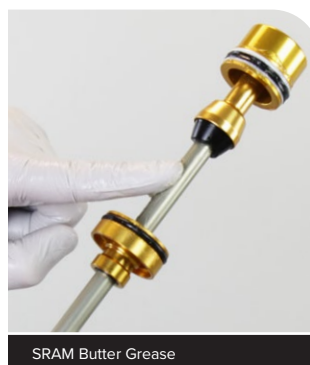

- 4 With the crown steerer upper tube assembly clamped in the bicycle work stand, orient the upper tubes upward and the steerer tube oriented downward.

Insert the air spring assembly into the upper tube. Firmly push the air piston into the upper tube.

Inject 1 mL of Maxima PLUSH Dynamic Suspension Lube Heavy into the upper tube, between the piston and sealhead, in the negative chamber.

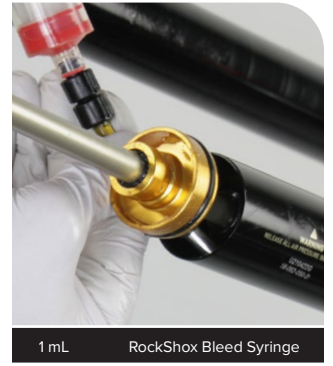
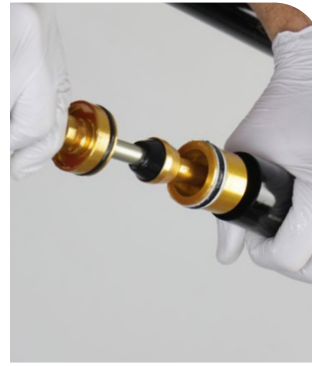

- 5 Insert the air sealhead into the upper tube and firmly press it into the upper tube until it stops.

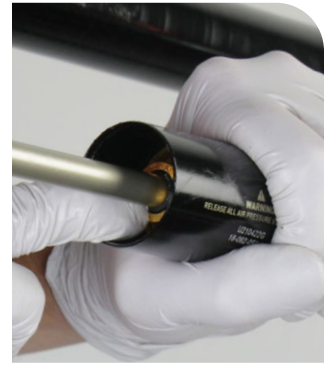

- 6 Remove the o-ring from the spring spacer and discard it. Apply grease to a new sealhead spacer o-ring and install it onto the sealhead spacer.

**Upgrade only - DebonAir+ Air Spring with ButterCups:** Apply grease to the o-ring on the sealhead spacer.

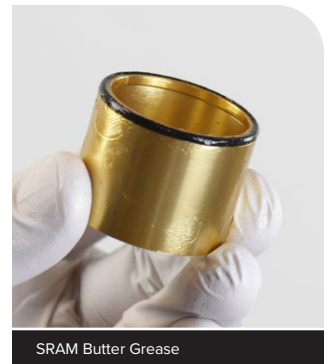



- 7 Insert the sealhead spacer into the upper tube, o-ring end first, and seat it into the upper tube step until it stops.

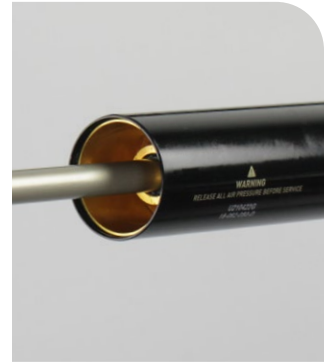
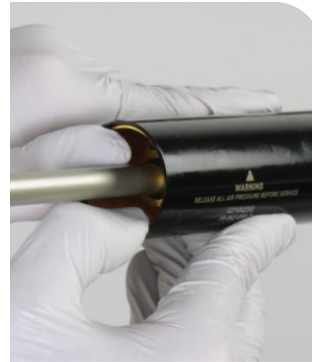

- 8 Install a section of protective split plastic tube, or a shop towel, around the air spring shaft to protect the shaft surface during installation.

**Ultimate** pictured.

**ZEB:** Eyelet retaining rings have a sharper edged side and a rounder edged side. Installing retaining rings with the sharper edged side facing the tool will allow for easier installation and removal.

Guide the retaining ring with your finger to prevent scratching the air shaft.

Place the tips of the retaining ring pliers into the eyelets of the retaining ring, then use the pliers to push the sealhead into the upper tube while installing the retaining ring into the groove.

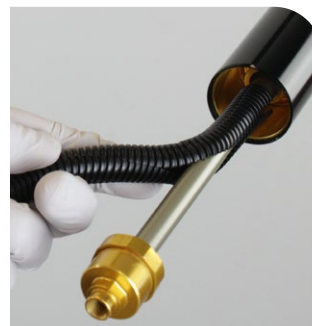

Split plastic tube



Retaining ring pliers

### NOTICE

Do not scratch the air spring shaft. Scratches will allow air to leak from the air spring, resulting in loss of air pressure and spring performance.

**Confirm the retaining ring is properly seated in the retaining ring groove by using the retaining ring pliers to rotate the retaining ring and sealhead back and forth a few times.**

### ⚠ WARNING - CRASH HAZARD

Retaining rings must be fully seated in the retaining ring groove. Confirm the retaining ring is fully seated in the retaining ring groove after installation. Failure to do so can result in **SERIOUS INJURY OR DEATH**.

Remove the split plastic tube or shop towel from the shaft.

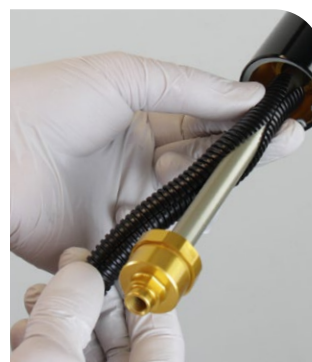



Install a section of protective split plastic tube, or a shop towel, around the air spring shaft to protect the shaft surface during installation.

Select+, Select, Base pictured.

### NOTICE

Do not scratch the air spring shaft. Scratches can cause air to leak. Replace the air spring assembly if a scratch is visible.

**Lyrik and Pike:** Lift both prong ends from the center of the ring to open the retaining ring for installation.

Insert the inner retaining ring prong end into the upper tube retaining ring groove.

Using your thumb, guide and push the retaining ring edge, starting at the installed prong end, around the upper tube edge and into the groove.

The retaining ring is installed completely when the outer prong end snaps into the groove.

**Confirm the retaining ring is properly seated completely in the retaining ring groove.**

### ⚠ WARNING - CRASH HAZARD

Retaining rings must be fully seated in the retaining ring groove. Confirm the retaining ring is fully seated in the retaining ring groove after installation. Failure to do so can result in **SERIOUS INJURY OR DEATH**.

Remove the split plastic tube or shop towel from the shaft.

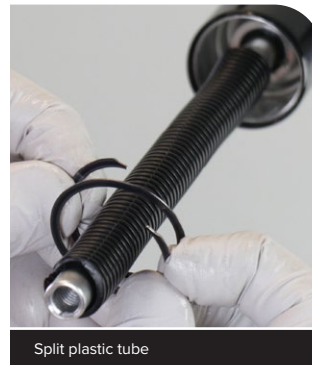

Split plastic tube

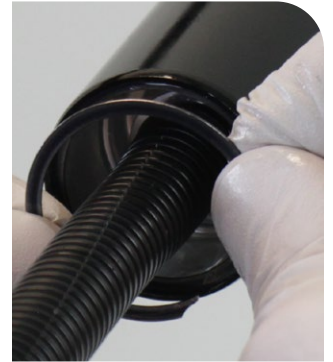
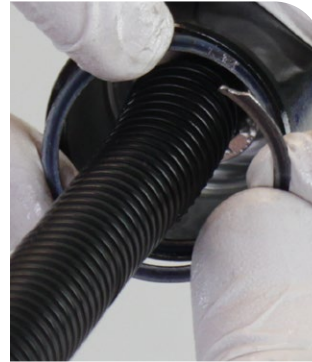
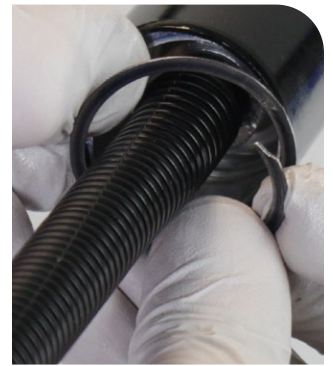

- 9 Inject or pour 3 mL Maxima PLUSH Dynamic Suspension Lube Heavy into the air spring upper tube.



3 mL

RockShox Bleed Syringe

- 10** Install the air spring top cap into the upper tube and tighten it. Press down firmly when tightening the top cap.

**⚠ WARNING - CRASH HAZARD**

Parts must be tightened to the specified torque. Failure to do so can result in SERIOUS INJURY OR DEATH.

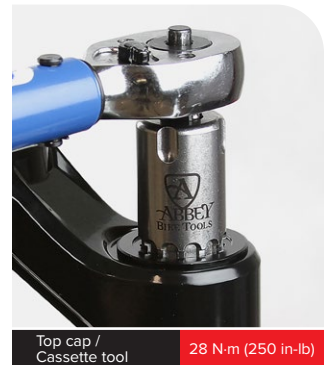

Top cap /  
Cassette tool

28 N-m (250 in-lb)

- 11** Install the Schrader valve core into the top cap and tighten it finger tight.



RockShox Schrader Valve Tool

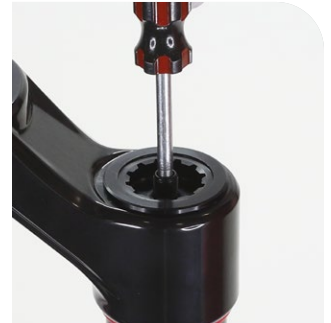

RockShox Schrader Valve Tool

- 200 Hour Service** To continue with damper service, proceed to the appropriate damper service section.

**Ultimate, Select+ - Charger 3 RC2 Damper:** [Damper Service - Charger 3 RC2](#)

**Select - Charger RC Damper:** [Damper Service - Charger RC](#)

**Base - Rush RC Damper:** [Damper Service - Rush RC](#)

**TRAVEL CHANGE Ultimate, Select+, Select, Base:** To complete travel change only, proceed to [Lower Leg Installation](#).

**UPGRADE - DEBONAIR+ AIR SPRING WITH BUTTERCUPS Select+, Select, Base:** To complete DebonAir+ air spring upgrade installation, proceed to [Lower Leg Installation](#).

ButterCups are NOT compatible with Dual Position Air. Do NOT install a ButterCups assembly onto a Dual Position Air spring shaft.

## 200 Hour Service Air Spring Removal

### NOTICE

Inspect each part for scratches. Do not scratch any sealing surfaces when servicing your suspension. Scratches can cause leaks.

When replacing seals and o-rings, use your fingers or a pick to remove the seal or o-ring. Spray RockShox Suspension Cleaner or isopropyl alcohol onto each part and clean with a clean lint-free shop towel.

Apply SRAM Butter grease to the new seals and o-rings.

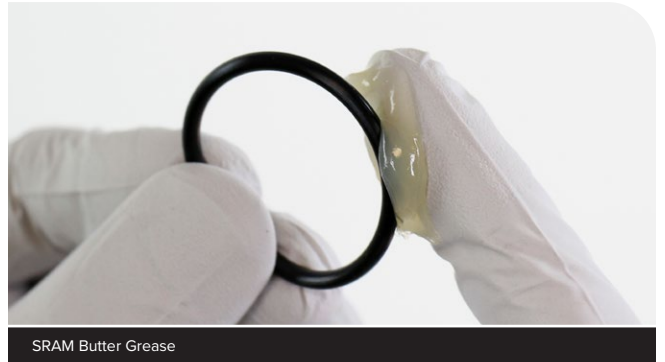

- 1 Clamp the fork in a bicycle work stand vertically with the steerer tube oriented upward.

### ⚠ WARNING - PRESSURIZED DEVICE

To avoid possible SERIOUS INJURY OR DEATH, position the fork vertically with the steerer tube upward so the top cap is directed upward and away from you and others.

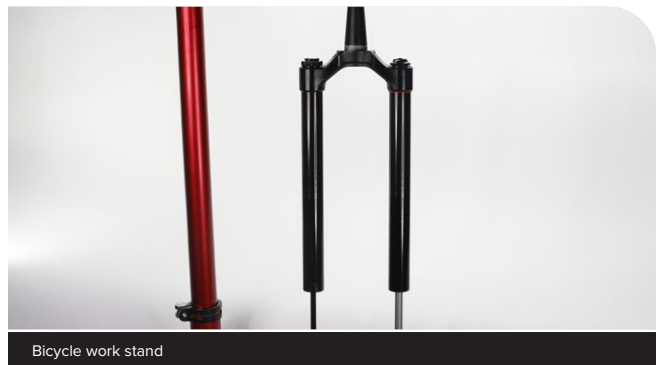

- 2 Confirm the Dual Position Air adjuster knob is set to the Maximum Travel position (full counterclockwise).

Confirm the Schrader valve core is NOT INSTALLED in the air spring top cap before proceeding. Remove the Schrader valve core if installed.

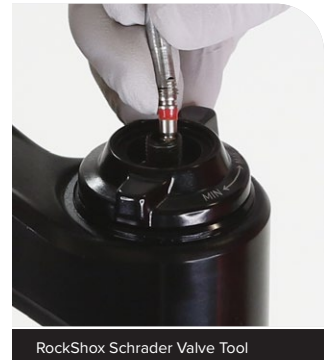

- 3 The positive and negative air spring chambers **must be FULLY depressurized** before removing the air spring top cap/upper air shaft assembly.

Slowly compress and extend (push up/pull down) the air spring shaft to allow any remaining negative air pressure to bypass the air transfer dimple on the inside surface of the upper tube.

The negative air spring chamber is fully depressurized when the shaft can be pulled to full extension. When released, the air spring shaft will retract into the upper tube slightly due to pressure created when the air piston is extended past the air bypass dimple in the upper tube. This is normal.

Repeat the process two to three times.

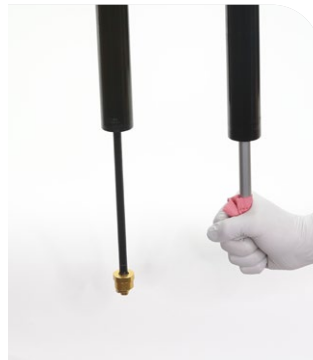

- 4 Remove the travel adjuster knob retaining nut.



Remove the travel adjuster knob.



5 **⚠ WARNING - PRESSURIZED DEVICE**

Always wear certified safety glasses (ANSI Z87.1, EN166 EU).

Verify all air pressure is removed from the suspension component. Failure to do so can result in **SERIOUS INJURY OR DEATH**. Refer to the Suspension Safety Precautions and Warnings section for detailed Pressurized Device warnings and instructions.

Unthread and remove the air spring top cap and upper air spring shaft assembly. Press down firmly when loosening the top cap.

**NOTICE**

The fork top caps are tightened to a high torque value. Ensure the fork is held securely in the bicycle stand. To avoid damage to the top cap, press the top cap / cassette tool squarely and firmly down when loosening. Use a socket wrench with a long handle for extra leverage.

Do not scratch the upper air spring shaft. Scratches can cause air to leak.

Clean the upper tube threads.



- 6 Remove the top cap o-ring and discard it.  
Apply grease to a new o-ring and install it.



- 7** Push the lower air shaft into the upper tube to prevent it from getting scratched while removing the retaining ring.

Remove the retaining ring.

**NOTICE**

Do not scratch the air spring shaft. Scratches can cause air to leak. Replace the air spring assembly if a scratch is visible.



Retaining ring pliers



Retaining ring pliers

- 8** Thread the shaft bolt into the end of the lower air spring shaft for added grip.

With the shaft pushed half way into the upper tube, quickly and firmly pull the shaft out to remove the sealhead and air spring assemblies from the upper tube.

Remove the shaft bolt from the air spring shaft.





- 9 Clean the inside and outside of the upper tube.  
Inspect the inside and outside of the upper tube for damage.

**NOTICE**

Scratches on the inside surface of the upper tube can cause air to leak. Replace the crown steerer upper tube assembly if a scratch is visible.



RockShox Suspension Cleaner



Dowel



Dowel



RockShox Suspension Cleaner

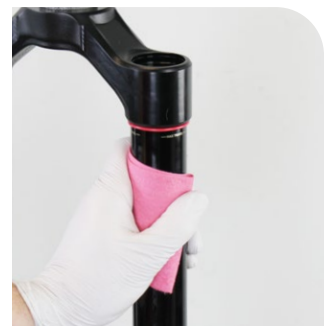



## DPA Air Spring Travel and Bottomless Tokens

To increase or decrease the travel in your RockShox ZEB fork, the air spring must be replaced with the appropriate length air spring shaft assembly. For example, to change a ZEB with a maximum of 160 mm of travel to a maximum of 180 mm of travel, a 180 mm air spring shaft assembly must be installed.

Bottomless Tokens can be added to, or removed from, the Dual Position Air (DPA) air spring assembly to fine-tune the bottom-out feel and spring curve. Use the chart below to help determine the number of Bottomless Tokens that can be used with each maximum fork travel option. If fork travel is changed from stock, it may be necessary to add or remove Bottomless Tokens.

Refer to the *RockShox Spare Parts Catalog* at [www.sram.com/service](http://www.sram.com/service) for available air spring and Bottomless Token kits. For part ordering information, please contact your local SRAM distributor or dealer.

ZEB - 27.5" Boost & 29" Boost		
Fork Travel (mm)	Bottomless Tokens (red) Factory Installed	Bottomless Tokens (red) Maximum
180	0	4
170	1	4
160	2	5

## DPA Bottomless Tokens Installation (optional)

Bottomless Tokens reduce air volume in your fork and create greater ramp at the end of the fork travel. Add Tokens to tune your fork's bottomless feel. Do not install more than the maximum number of Bottomless Tokens for your fork.

Install Bottomless Token(s) onto the DPA air spring shaft, as desired.



## DPA Air Spring Travel Change and Bottomless Tokens (optional)

It is optional to change maximum fork travel by replacing the stock air spring shaft assembly with a shorter or longer air spring shaft assembly. If maximum travel is increased or reduced, use the new complete air spring shaft assembly in the following installation steps. It may also be necessary to add or remove Bottomless Tokens. Refer to [Air Spring Travel Change and Bottomless Tokens](#) for details.

Refer to the *RockShox Spare Parts Catalog* available at [www.sram.com/service](http://www.sram.com/service) for the required spare part kits.

For part ordering information, please contact your local SRAM distributor or dealer.

### 200 Hour Service Air Spring Service

- 1 Remove the sealhead and top out bumper from the air spring shaft.  
Discard the sealhead.  
Clean and inspect the shaft for damage.  
Clean the top out bumper.

#### NOTICE

Do not scratch the air spring shaft. Scratches can cause air to leak.  
Replace the air spring assembly if a scratch is visible.

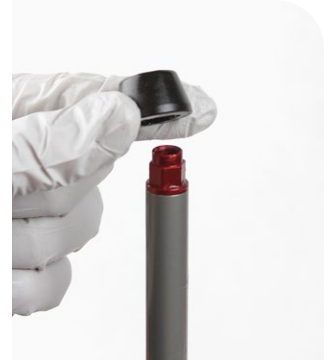

- 2 Remove the inner and outer air piston o-rings and discard them. Clean the air piston.



Apply grease to new o-rings and install them.

#### NOTICE

Do not scratch the air piston. Scratches can cause air to leak.  
Replace the air spring assembly if a scratch is visible.



SRAM Butter Grease

- 3 Install the top out bumper onto the shaft.  
Apply a liberal amount of grease to the air spring shaft.

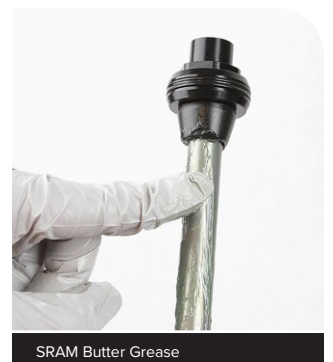

SRAM Butter Grease

**4** Apply grease to the new seal o-ring and wiper seal.

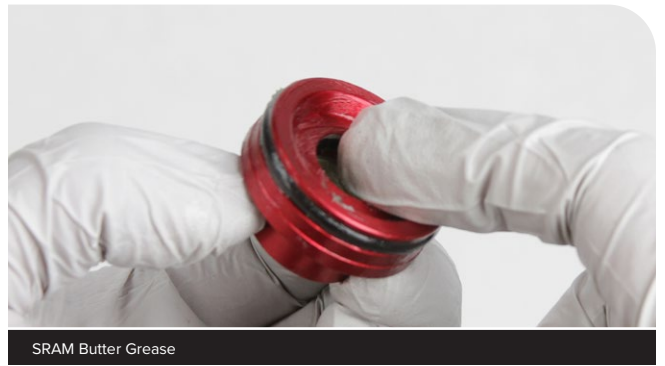

**5** Install the retaining washer/backup ring, a new wave spring, and the new sealhead assembly, in that order, onto the air shaft.



**6** Apply grease to the air piston and sealhead outer o-ring/seals.

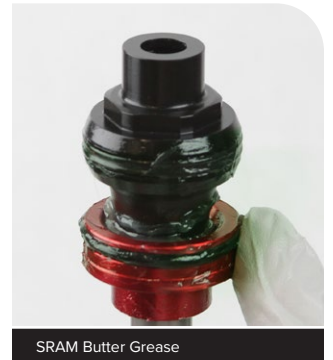
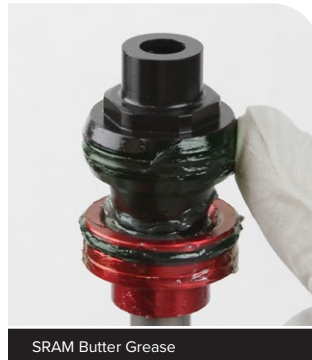

- 1 Apply a liberal amount of SRAM Butter grease evenly around the end of a clean plastic dowel, approximately 60 mm from one end. Use the dowel to apply the grease to the inside surface of the upper tube, approximately 60 mm into the tube.

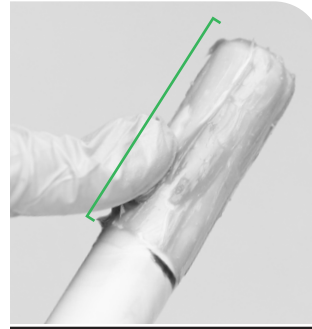

Dowel and grease

60 mm

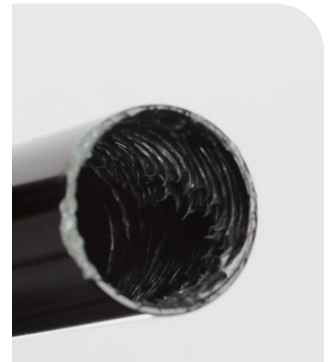

- 2** Insert the air spring piston into the upper tube. Firmly push the air spring piston into the upper tube.
- Inject 1 mL of Maxima PLUSH Dynamic Suspension Lube Heavy into the upper tube, between the piston and sealhead, in the negative chamber.
- Insert the sealhead into the upper tube. Firmly press the sealhead into the upper tube until it stops.
- Insert the sealhead spacer into the upper tube. Firmly press the sealhead spacer into the upper tube until it stops.

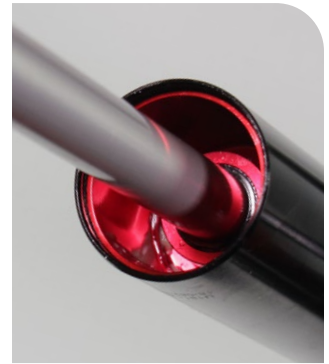
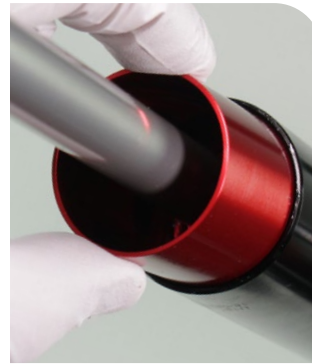
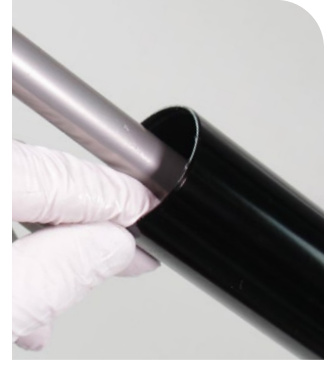
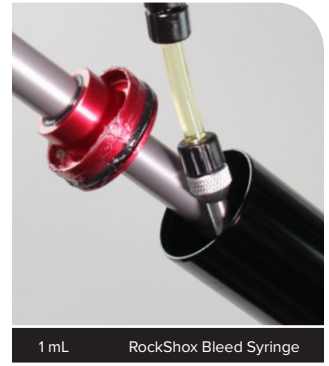

- 3** *Retaining rings have a sharper-edged side and a rounder edged side. Installing retaining rings with the sharper-edged side facing the tool will allow for easier installation and removal.*

Push the lower air shaft into the upper tube to prevent it from getting scratched while installing the retaining ring.

Place the tips of the retaining ring pliers into the eyelets of the retaining ring, then use the pliers to push the sealhead into the upper tube while installing the retaining ring into the groove.

**Confirm the retaining ring is properly seated in the retaining ring groove by using the retaining ring pliers to rotate the retaining ring and sealhead back and forth a few times, then firmly pull down on the air shaft.**

**⚠ WARNING - CRASH HAZARD**

Retaining rings must be fully seated in the retaining ring groove. Confirm the retaining ring is fully seated in the retaining ring groove after installation. Failure to do so can result in **SERIOUS INJURY OR DEATH**.

**NOTICE**

Do not scratch the air spring shaft. Scratches can cause air to leak. Replace the air spring assembly if a scratch is visible.

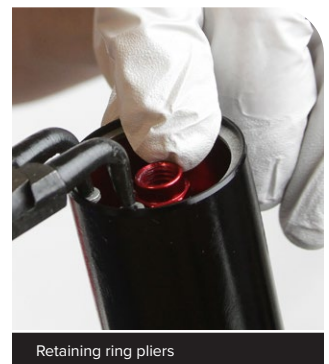
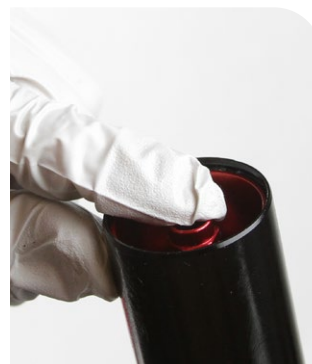

- 4** Thread a bottom bolt into the shaft 2 to 3 turns and pull the lower air shaft out to approximately half way.  
Remove the bolt.



- 5** Apply a liberal amount of grease to the top cap upper air spring shaft.



- 6** Install the upper air spring shaft into the upper tube and into the air piston and lower air spring shaft.  
The upper air spring shaft must be installed into the air piston and lower air spring shaft before oil is added to the positive air chamber.

**NOTICE**

Do not scratch the air spring shaft. Scratches can cause air to leak. Replace the air spring assembly if a scratch is visible.



- 7** Inject or pour 3 mL Maxima PLUSH Dynamic Suspension Lube Heavy into the air spring upper tube.





- 8** Thread the top cap assembly into the upper tube and tighten it. Press down firmly when tightening the top cap.

**⚠ WARNING - CRASH HAZARD**

Parts must be tightened to the specified torque. Failure to do so can result in **SERIOUS INJURY OR DEATH**.



24 mm

28 N·m (250 in·lb)

- 9** Place the adjuster knob onto the top cap with the long tab near the back of the crown. Turn the adjuster knob counterclockwise until it engages the first detent space.



Thread the knob retaining nut onto the threaded air valve body and tighten the knob retaining nut.



10 mm

2 N·m (18 in·lb)

- 10** Install the Schrader valve core into the top cap and tighten it finger tight.



RockShox Schrader Valve Tool

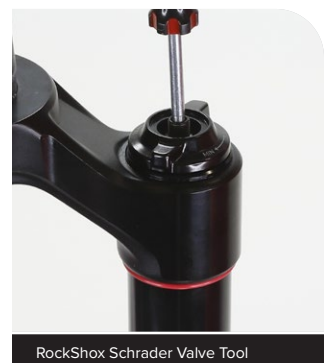

RockShox Schrader Valve Tool

**200 Hour Service** **Ultimate, Select+ - Charger 3 RC2 Damper:** Continue with [Damper Service - Charger 3 RC2](#).

**200 Hour Service** **Select - Charger RC Damper:** Continue with [Damper Service - Charger RC](#).

**200 Hour Service** **Base - Rush RC Damper:** Continue with [Damper Service - Rush RC](#).

**CAUTION**

Place an oil pan on the floor underneath the product during service to catch any drained or spilled fluids. To avoid a slip and fall, and possible injury or harm, immediately clean any oil, fluid, grease, or lubricant from the floor in your work area.

**NOTICE**

Inspect each part for scratches. Do not scratch any sealing surfaces when servicing your suspension. Scratches can cause leaks.

When replacing seals and o-rings, use your fingers or a pick to remove the seal or o-ring. Spray RockShox Suspension Cleaner or isopropyl alcohol onto each part and clean with a clean lint-free shop towel.

Apply SRAM Butter grease to the new seals and o-rings.

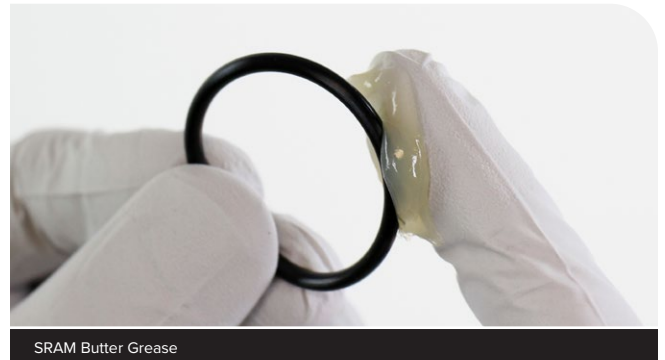

- 1 Rotate the compression adjuster knobs counterclockwise, to the full open positions, until they stop.

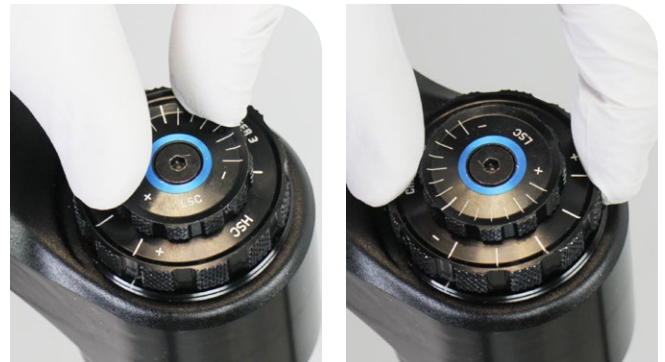

- 2 Remove the (LSC) low speed compression knob retaining screw. Remove the LSC adjuster knob.



- 3** Loosen the (HSC) high speed compression knob set screw. Do not remove the set screw.

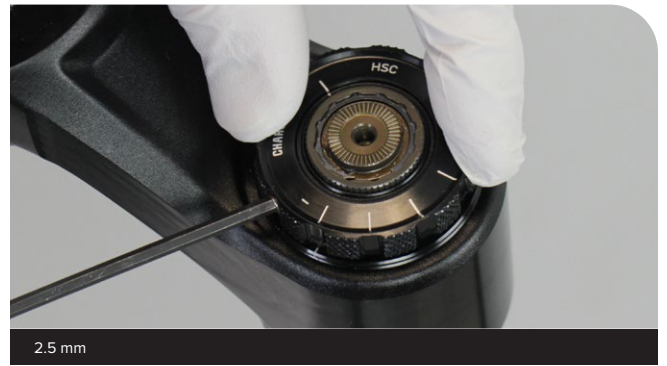

- 4** Remove the (HSC) high speed compression adjuster knob.  
Remove the detent plate.

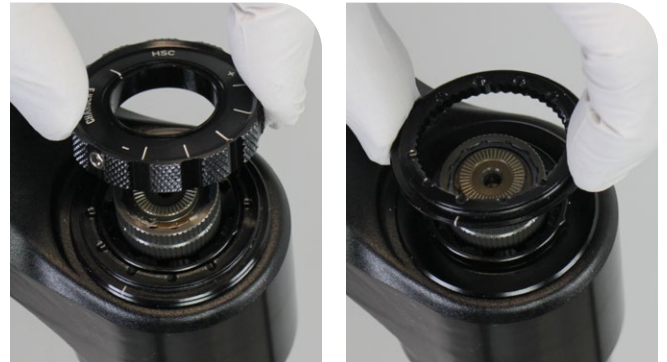

- 1 Unthread the damper top cap and remove the damper assembly. Press down firmly when loosening the top cap.

**NOTICE**

The fork top caps are tightened to a high torque value. Ensure the fork is held securely in the bicycle stand. To avoid damage to the top cap, press the top cap / cassette tool squarely and firmly down when loosening. Use a socket wrench with a long handle for extra leverage.



Top cap / Cassette tool



- 2 Clean the inside and outside of the upper tube.  
Clean the upper tube threads.



RockShox Suspension Cleaner



Dowel



Dowel

**200 Hour Service Ultimate - Charger 3 RC Damper - Damper Service:** Continue with [ButterCups Removal - Damper Shaft - Charger 3 RC2 - Ultimate](#).

**200 Hour Service Select+ - Charger 3 RC Damper - Damper Service:** Continue with [Damper Service - Charger 3 RC2](#).

**UPGRADE - CHARGER 3 RC2 DAMPER WITH BUTTERCUPS Select+, Select, Base:** To install a Charger 3 RC2 damper assembly with pre-installed ButterCups, proceed to [Damper Installation - Charger 3 RC2](#).

- 1 Clamp the lower ButterCups housing into a vise with Reverb Vise Blocks on the wrench flats, with the damper oriented upward.  
Hold the damper shaft for support and unthread the upper ButterCups housing (25 mm) from the lower housing.



Adjustable or 25 mm open end wrench



- 2 Remove the damper assembly from the lower cup and set it aside.

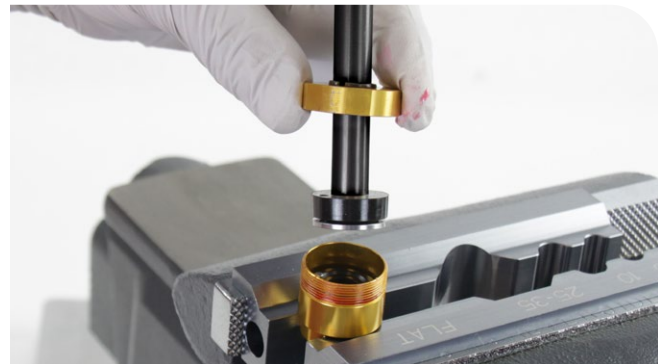

- 3 Remove the lower ButterCups bumper from the lower ButterCups housing and discard it.  
Do not remove the alignment bolt.

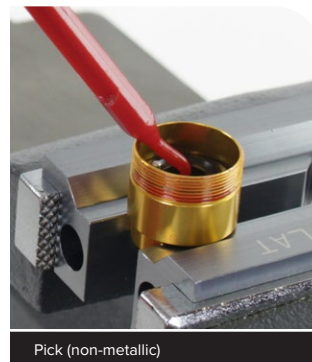

Pick (non-metallic)



- 4 Remove the lower ButterCups housing from the vise. Clean the lower ButterCups housing.

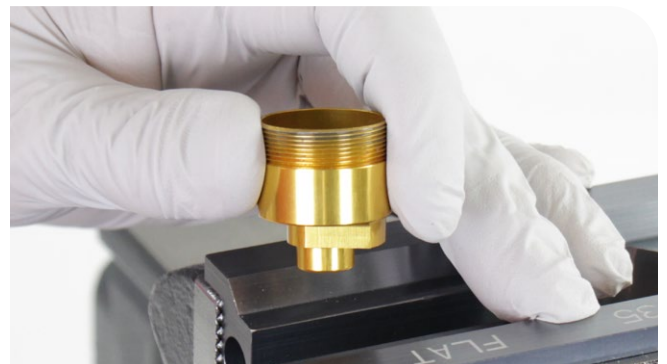



- 5** Clamp the damper shaft into the 10 mm slot of the Reverb Vise Blocks or RockShox Rear Shock Vise Blocks with the damper oriented downward.

Clamp the damper shaft only tight enough so it does not spin when the ButterCups shaft end plate is removed.

### NOTICE

Scratches can cause oil to leak. Replace the rebound damper assembly if a scratch is visible.

Do not clamp the rebound damper shaft in the middle of the shaft. Clamping force will damage the rebound damper shaft. If the rebound damper shaft is damaged, the rebound damper assembly must be replaced.

Unthread and remove the ButterCups shaft end plate from the damper shaft.

- 6** Remove the upper ButterCups bumper and discard it.  
Remove the upper ButterCups housing and bushing assembly from the damper shaft.

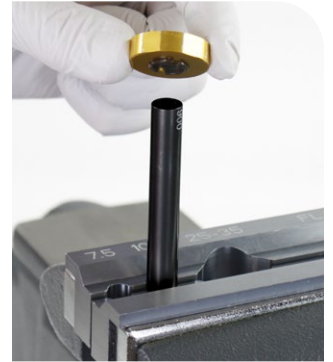
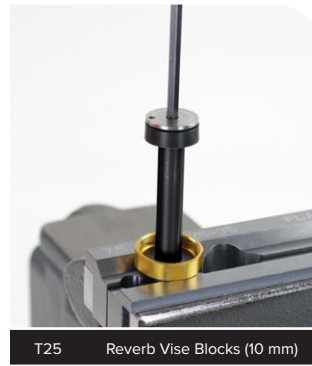



- 1 Clamp the damper IFP tube coupler (red) in a vise with Reverb Vise Blocks, top cap oriented upward.



Hold and secure the IFP tube with an open end wrench (28mm).  
 Unthread the top cap from the IFP tube. Press down on the socket wrench and top cap until the top cap is completely unthreaded.

**CAUTION**

The top cap is spring loaded by the IFP spring. To prevent the spring and top cap from ejecting outward when it is unthreaded, press down on the socket wrench and top cap while unthreading the top cap.

Always wear safety glasses. Do not allow oil, fluid, grease, lubricant, or cleaner to contact your eyes or face. Seek immediate medical attention if irritation occurs.



- 2 Remove the top cap and IFP spring from the IFP tube.

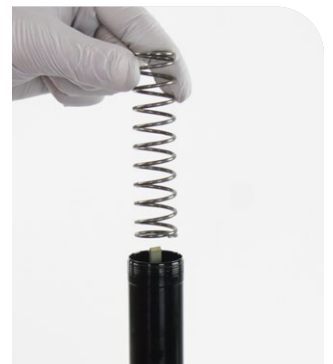

- 3 Remove the damper assembly from the vise.  
 Clamp the cartridge tube, on the wrench flats, into the vise with the rebound damper oriented upward.



- 4 Secure a shop towel around the cartridge tube under the sealhead to absorb oil.

Unthread the sealhead from the cartridge tube.



Adjustable or 23 mm open end wrench



**Two-Piece Rebound Sealhead:** Unthread the red section of the sealhead from the cartridge tube.

**NOTICE**

To avoid separation of the two sealhead sections, only unthread the sealhead from the cartridge tube at the red section.

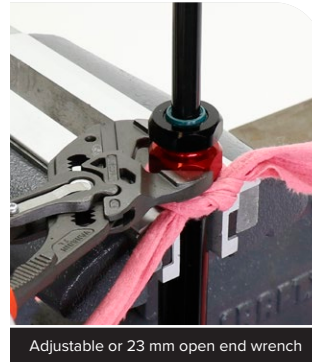

Adjustable or 23 mm open end wrench

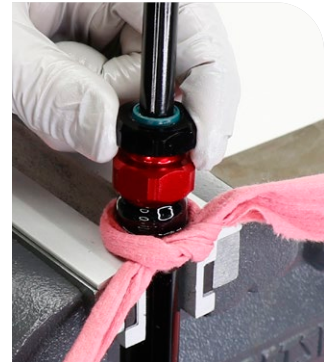

- 5 Remove the sealhead and rebound damper from the cartridge tube.

**CAUTION**

Always wear safety glasses. Do not allow oil, fluid, grease, lubricant, or cleaner to contact your eyes or face. Seek immediate medical attention if irritation occurs.



- 6 Remove the sealhead assembly from the rebound damper.  
Discard the sealhead assembly.



- 7 Clean the rebound damper assembly, check for scratches on the shaft, and set it aside.

**NOTICE**

Scratches can cause oil to leak. Replace the rebound damper assembly if a scratch is visible.



- 8 The solid band glide ring is not removable and only requires cleaning. Do not remove.

**NOTICE**

Do not remove the solid band glide ring. The solid band glide ring is not serviceable. Removal of the solid band glide ring will require a new damper assembly.

The color of the solid band glide ring may vary.



- 9 Remove the cartridge tube from the vise and pour the damper oil into an oil pan.

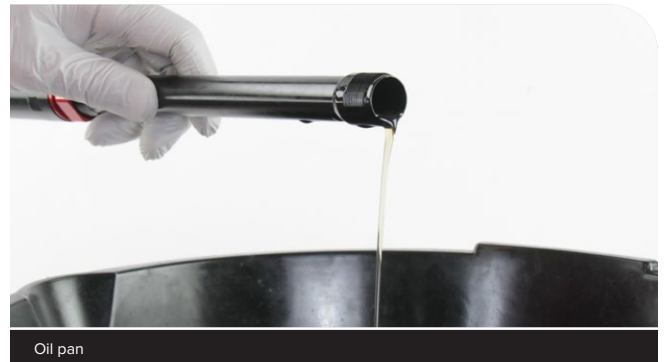

- 10 Clamp the damper tube assembly back into the vise on the IFP tube coupler (red) hex wrench flats, with the IFP tube oriented upward. Unthread and remove the IFP tube assembly from the IFP coupler (red). Remove the cartridge tube from the vise and set it aside.



**11** The IFP tube assembly may contain damping oil. Hold the IFP tube assembly, with the exterior hex end downward, over shop towel.

From the exterior threaded end of the IFP tube, press the adjuster tab and push the compression damper assembly out of the IFP tube until the piston assembly exits the IFP tube. Oil will drain onto the shop towel.

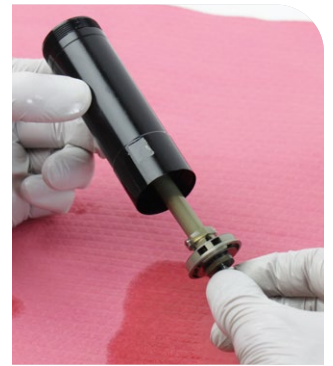
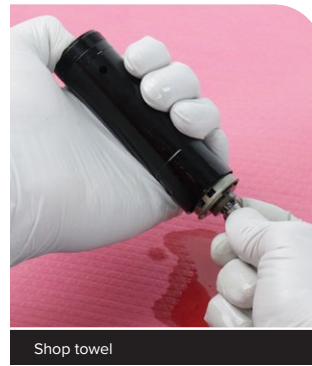

**12** With the piston above the Reverb Vise Blocks, lightly clamp the compression damper hex cam into the vise. Do not clamp on the set screws.

The IFP tube should be below the vise blocks.

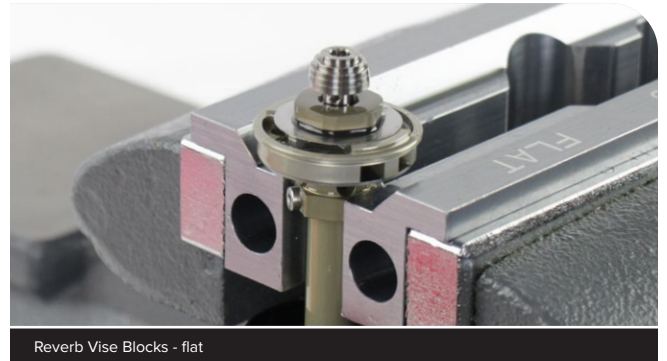

**13** Unthread and remove the (HSC) high speed compression nut from the compression damper assembly.

Set the nut aside.

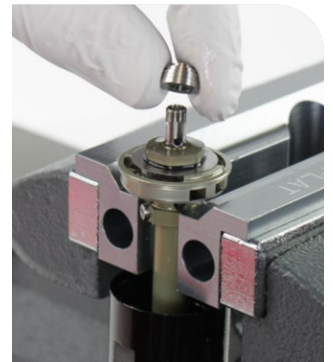
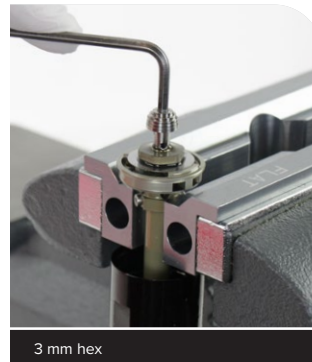

- 14** Remove the compression damper assembly and IFP tube from the vise.  
Unthread and remove each cam set screw (x2).  
Set the set screws aside.

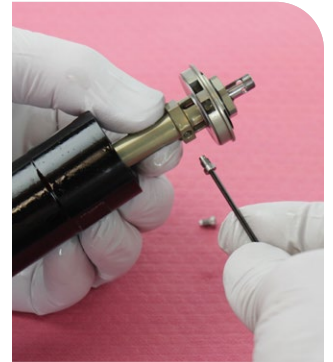
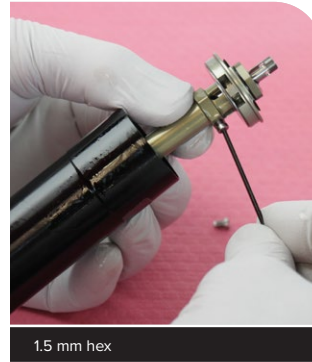
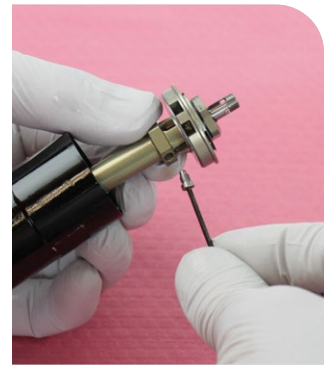
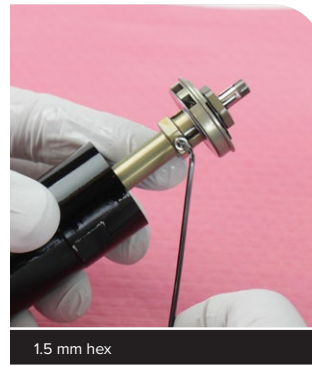

- 15** Remove the (LSC) low speed compression assembly from the (HSC) high speed compression/piston assembly.  
Spray the assembly with RockShox Suspension Cleaner or isopropyl alcohol and set it aside.

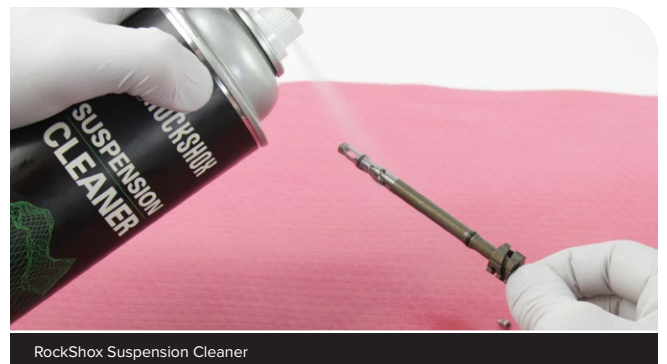
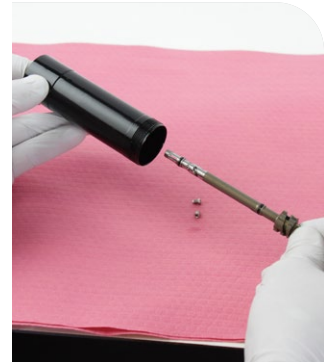



**16** Remove the (HSC) high speed compression/piston assembly from the IFP tube.

Spray the assembly with RockShox Suspension Cleaner or isopropyl alcohol and set it aside.

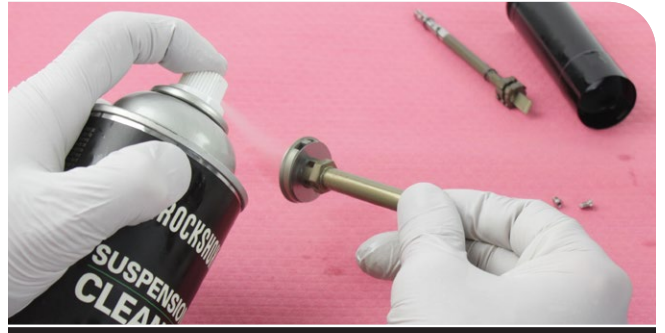
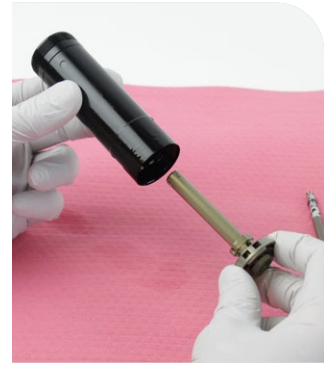

RockShox Suspension Cleaner

**17** Push the IFP out of the IFP tube and remove it.

**NOTICE**

Do not scratch the inside surface of the IFP tube. Scratches can cause oil to leak. Replace the IFP tube if a scratch is visible.

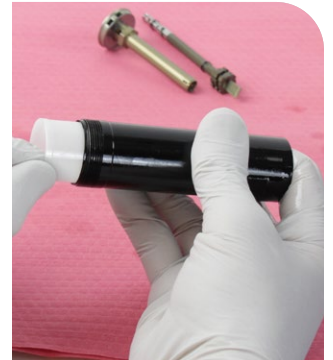



18 Clean the IFP tube and inspect it for scratches. Set the IFP tube aside.

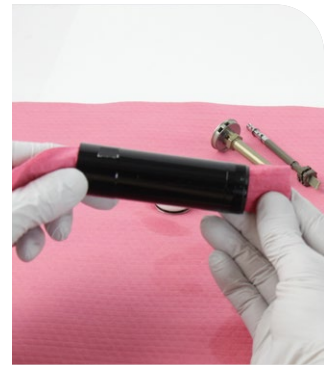
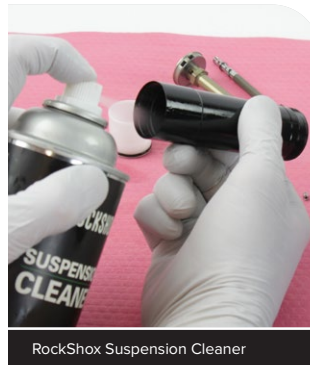

- 19 Remove the inner and outer IFP o-rings and discard them.  
Clean the IFP and inspect it for scratches.

**NOTICE**

Do not **SCRATCH** the o-ring grooves in the IFP. Scratches will cause oil to leak. The IFP **MUST** be replaced if a scratch is visible in the o-ring grooves.

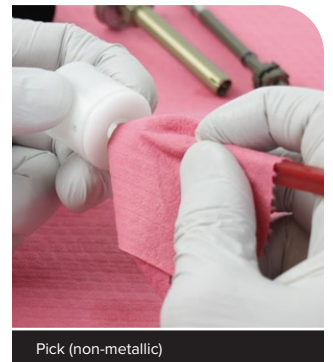
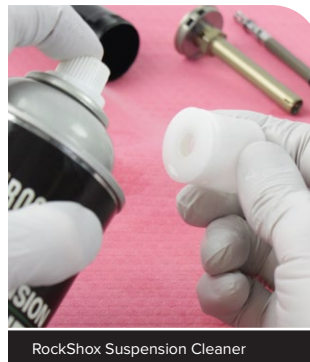
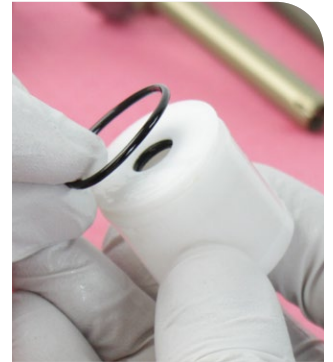
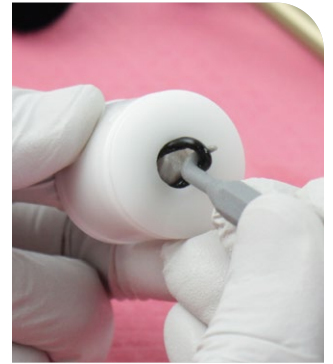
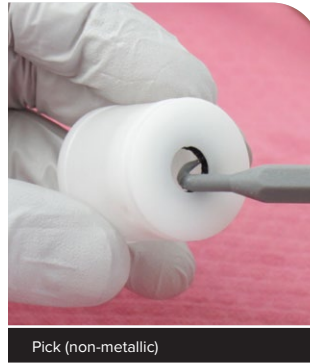

- 1 Apply grease to the new inner and outer IFP o-rings and install them onto the IFP.

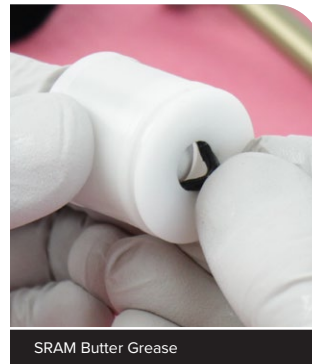

SRAM Butter Grease

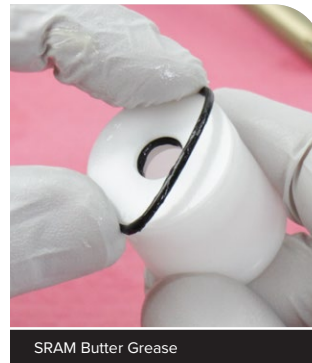
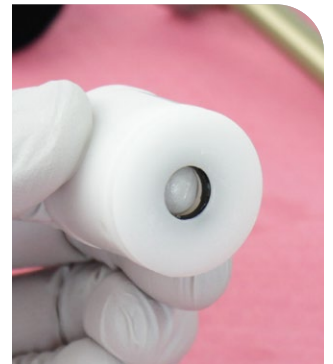

SRAM Butter Grease

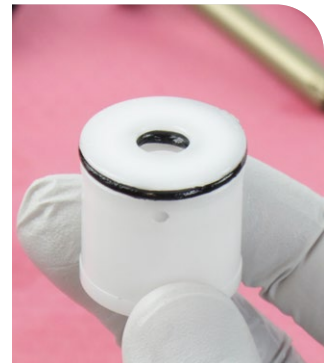

- 2 Apply a thin coat of suspension oil to the inner surface of the IFP tube.

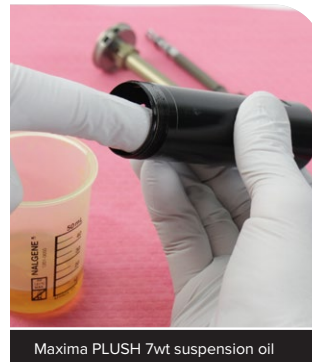

Maxima PLUSH 7wt suspension oil



**3** Insert and install the IFP into the IFP tube, flat end/outer o-ring first, into the outer threaded end of the IFP tube.

Press the IFP into the IFP tube until it is approximately 30 mm from the end of the opposite (internal threads) end of the tube.

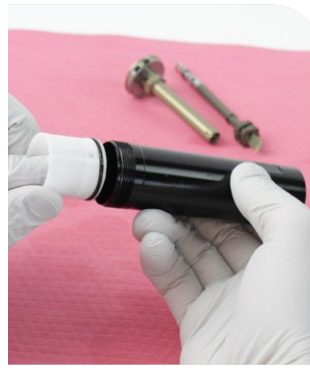

**4** Apply a light coat of suspension oil to the (HSC) high speed compression/piston assembly shaft (outer/wider shaft).

From the hex end of the IFP tube, insert the (HSC) high speed compression/piston assembly into and through the center of the IFP.

Press it into the IFP until the piston assembly is approximately 20 mm above the internal thread end of the IFP tube.

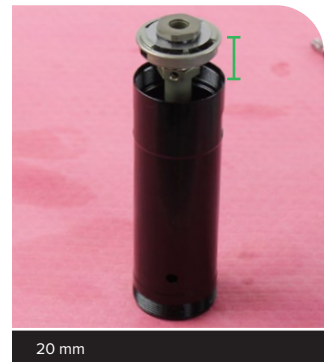
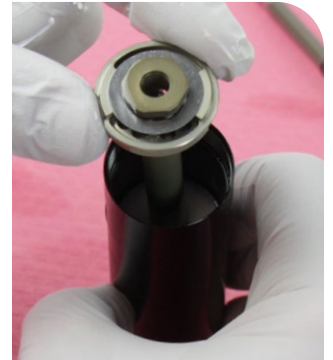
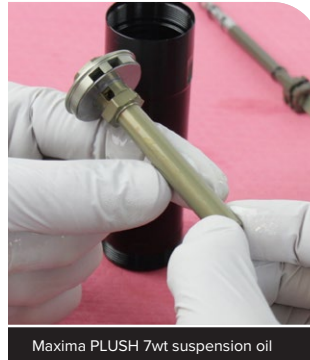

- 5** Apply suspension oil to the (LSC) low speed compression/piston assembly shaft and o-rings (inner/narrow shaft).

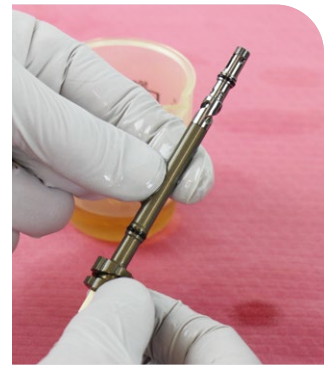
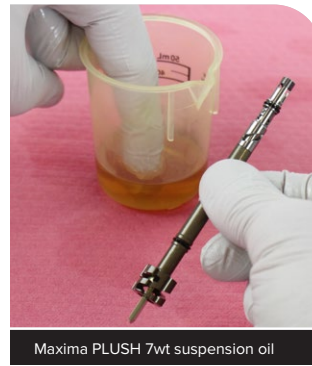

- 6** Hold the piston to keep it from moving.

From the external threaded end of the IFP tube, insert the (LSC) low speed compression shaft assembly, silver narrow end first, into the (HSC) high speed compression/piston assembly shaft.

Push the (LSC) low speed compression/piston assembly until the narrow silver shaft end protrudes through the piston bolt, until it stops, snaps into place, and is completely seated. The narrow end of the LSC shaft should protrude through the piston bolt.

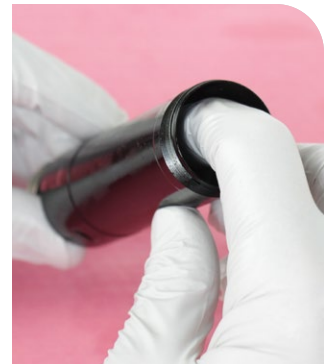
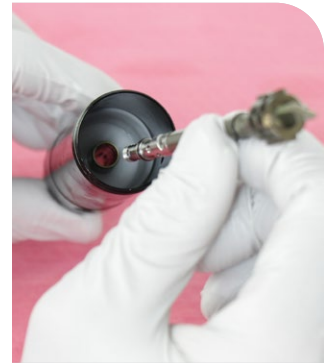



**7** Install each cam set screw (2 total) evenly finger tight. Tighten each to the specified torque.

The set screws secure the (LSC) low speed compression shaft in the (HSC) high speed compression shaft.

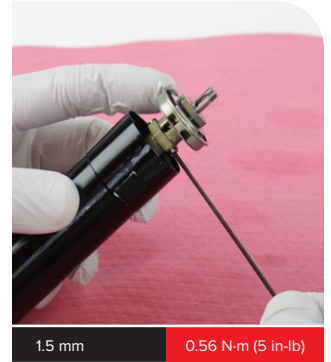
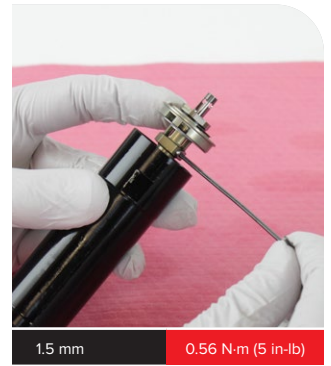
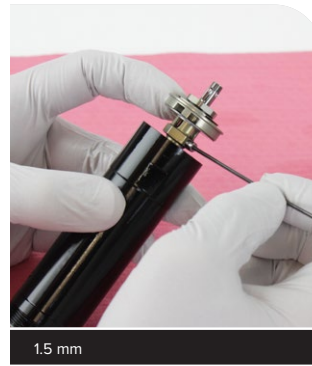

**8** Pull the piston up until it is above the end of the IFP tube.

Clamp the (HSC) high speed compression assembly into the vise at the cam hex wrench flats. The piston should be above the vise blocks and the IFP tube should be below the vise blocks.

Do not clamp on the set screws.

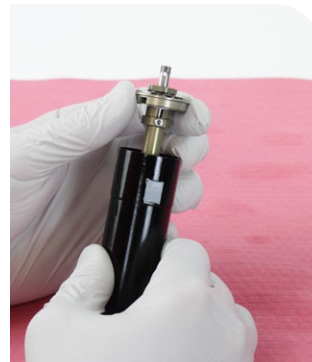



- 9** Install the compression nut onto the inner (LSC) low speed compression rod end and tighten it.
- The LSC adjuster will rotate when the nut is tightened. Rotate it counterclockwise back to full extension after the nut is tightened. Remove the assembly from the vise.

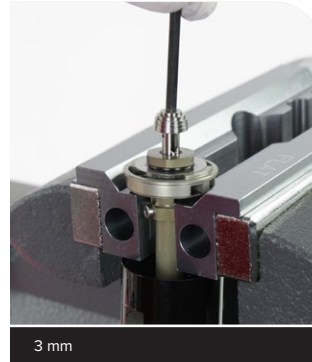
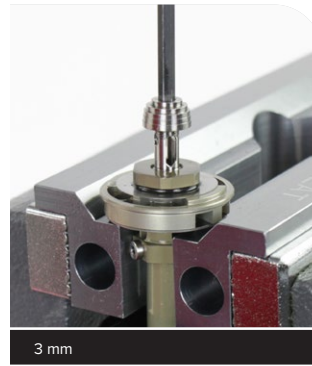

- 10** **Set the IFP:** Using a non-metallic pick, push the IFP evenly into the IFP tube until the hollow end (opposite side) is just below the IFP tube bleed port hole (A). The IFP should not cover the bleed port hole.

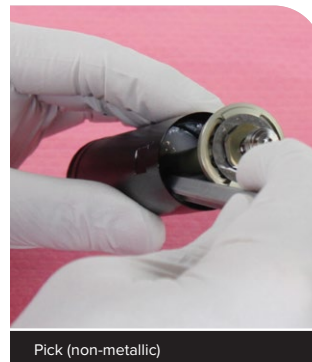

**11** Push the piston down until it is approximately 10 mm above the end of the IFP tube.

Inject suspension oil into the IFP tube until it is full. Oil will fill the IFP tube above the IFP and below the piston.



**12** Hold a shop towel around the IFP tube.

Push the piston down and into the IFP tube until it stops.

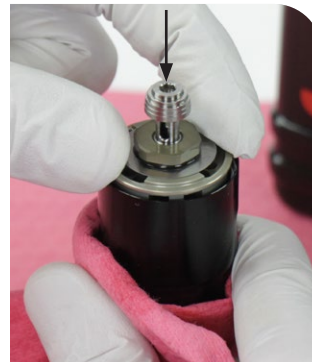

**13** Remove the o-ring from the red cartridge tube coupler and discard it.  
Clean the o-ring groove.

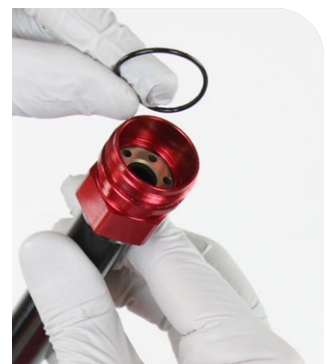

- 14** Spray RockShox Suspension Cleaner into the cartridge tube and set it upright on a shop towel to drain.

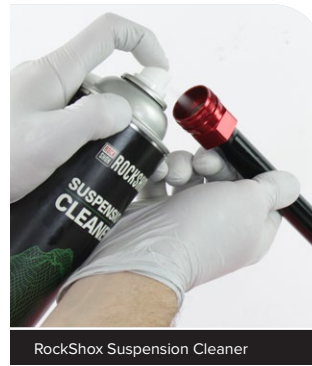

- 15** Apply grease to a new o-ring and install it onto the red coupler.

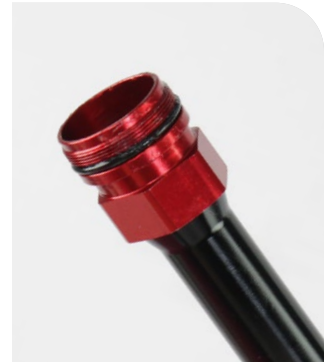
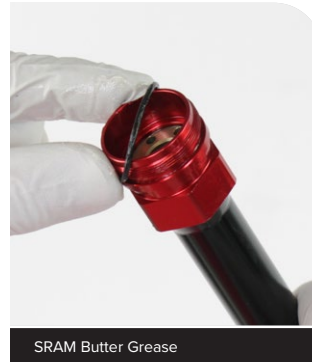

- 16** Hold the IFP secure so it does not move.  
Thread the IFP tube coupler onto the IFP tube and tighten it hand tight.

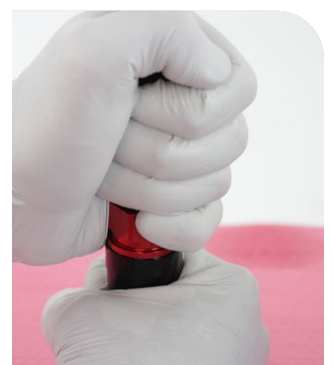

- 17 Clamp the cartridge tube assembly into the vise at the wrench flats with the IFP tube/assembly oriented downward.



- 18 Tighten the IFP tube and IFP coupler onto the cartridge tube. When tightened, the IFP tube, IFP coupler, and cartridge tube will all be tightened to the same torque.

**⚠ WARNING - CRASH HAZARD**

Parts must be tightened to the specified torque. Failure to do so can result in **SERIOUS INJURY OR DEATH**.



- 19 Secure a shop towel around the cartridge tube.  
Pour suspension oil into the cartridge tube until it is full.



- 20 Apply grease to the wiper seal on the new rebound damper sealhead assembly.



- 21** Install the sealhead assembly onto the rebound damper shaft and slide it to the rebound piston until it stops.



- 22** Clean the grease from the shaft threads.

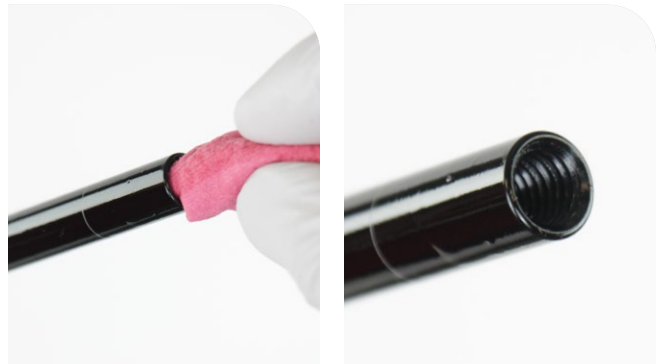

- 23** Insert the rebound adjuster knob in the rebound shaft and rotate counterclockwise until it stops. This is the full open rebound setting.





- 24** Secure a shop towel around the damper tube to absorb displaced oil. While pulling up on the rebound damper to maintain contact with the sealhead, insert the rebound damper piston into the cartridge tube. Continue to apply opposing pressure to the sealhead with the rebound damper and thread the sealhead onto the end of the cartridge tube until it is hand tight.

**NOTICE**

Do not push the rebound damper into the cartridge tube while threading the sealhead onto the cartridge tube.

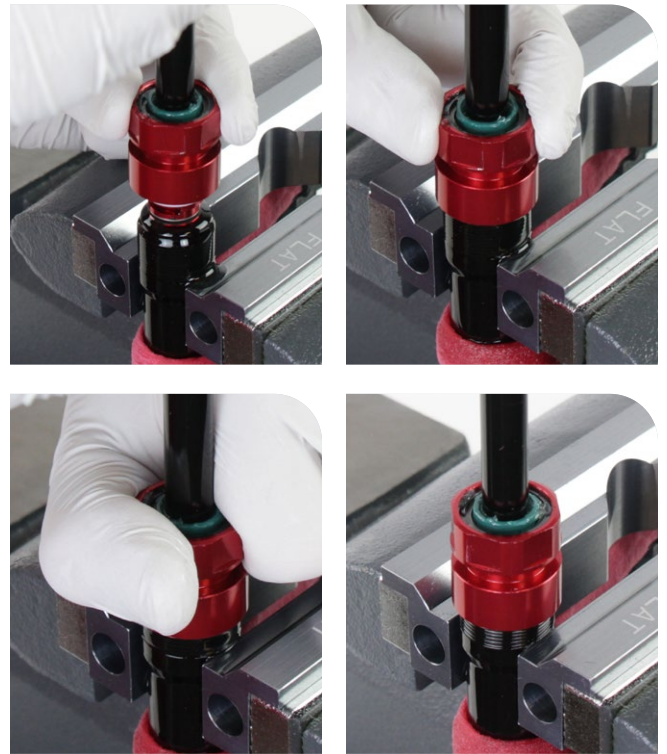

- 25** Tighten the sealhead to the specified torque.

**Two-Piece Rebound Sealhead:** Tighten the red section of the sealhead to the cartridge tube.

**⚠ WARNING - CRASH HAZARD**

Parts must be tightened to the specified torque. Failure to do so can result in SERIOUS INJURY OR DEATH.

**NOTICE**

Scratches can cause oil to leak. Replace the rebound damper assembly if a scratch is visible.

Remove the damper from the vise.

Clean damper assembly.



23 mm

14 N·m (125 in·lb)



23 mm

14 N·m (125 in·lb)



**200 Hour Service** **Select+:** Charger 3 RC2 Damper - Damper Service: Continue with [Damper Bleed - Charger 3 RC2](#).



**NOTICE**

The Ultimate Charger 3 RC2 damper shaft ButterCups assembly is NOT compatible with Select+ Charger 3 RC2, Select Charger RC, and Base Rush RC rebound damper shafts. Do NOT install a damper shaft ButterCups assembly onto a Select+ Charger 3 RC2, Select Charger RC, or Base Rush RC damper shaft.

- 1 Install the upper ButterCups housing and bushing assembly onto the damper shaft. Slide the assembly toward the rebound sealhead until it stops.

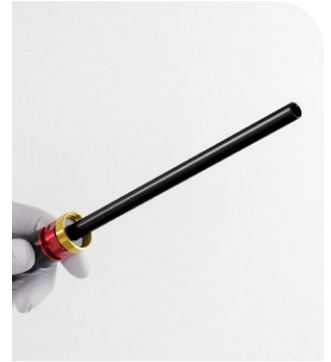
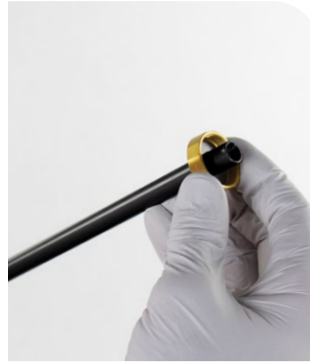

- 2 Install a new upper ButterCups bumper, wide end first, onto the damper shaft.



- 3 Apply Threadlocker Loctite 2760 (red), or equivalent, to the first three full threads on the end of the end plate.

**⚠ WARNING - CRASH HAZARD**

To avoid separation of parts, threadlocker must be applied as instructed. Failure to apply threadlocker could result in separation of the parts, and possible **SERIOUS INJURY OR DEATH**.

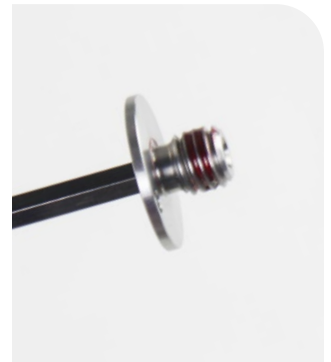
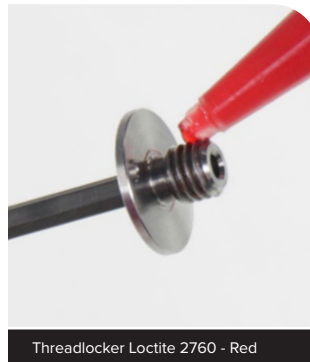

Threadlocker Loctite 2760 - Red

- 4** Clamp the damper shaft into the 10 mm slot of the Reverb Vise Blocks or RockShox Rear Shock Vise Blocks.

Clamp the damper shaft only tight enough so it does not spin when the ButterCups shaft end plate is tightened.

**NOTICE**

Scratches can cause oil to leak. Replace the rebound damper assembly if a scratch is visible.

Do not clamp the rebound damper shaft in the middle of the shaft. Clamping force will damage the rebound damper shaft. If the rebound damper shaft is damaged, the rebound damper assembly must be replaced.

Thread the ButterCups shaft end plate into the damper shaft and tighten it.

**⚠ WARNING - CRASH HAZARD**

Parts must be tightened to the specified torque. Failure to do so can result in **SERIOUS INJURY OR DEATH**.



- 5** Install the lower ButterCups housing bumper into the lower ButterCups housing, wide side down, in alignment with the bolt.



- 6** Apply Threadlocker Loctite 242 (blue), or equivalent, to three full outer threads on the lower ButterCups housing.

**⚠ WARNING - CRASH HAZARD**

To avoid separation of parts, threadlocker must be applied as instructed. Failure to apply threadlocker could result in separation of the parts, and possible **SERIOUS INJURY OR DEATH**.

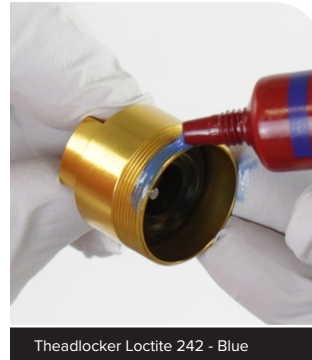

**7** Position the upper ButterCups housing and bumper **above** the vise blocks.

Install the lower ButterCups housing/bumper assembly onto the ButterCups shaft end plate; insert the bolt through the end plate bolt hole.

Slide lower cup to the upper bumper end plate, and position the alignment bolt through the hole on the end plate.

Thread the upper ButterCups housing onto the lower ButterCups housing finger tight.

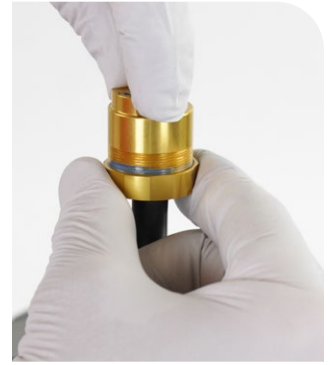
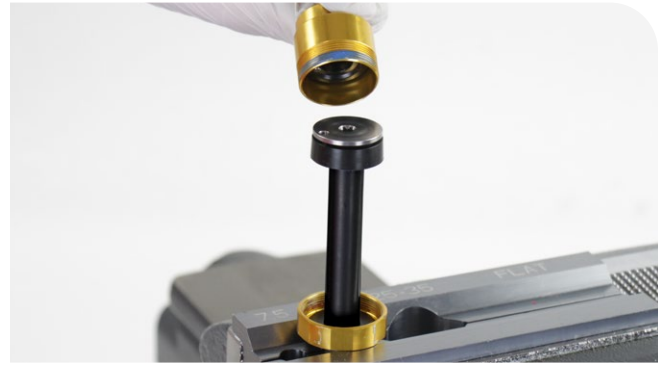

**8** Remove the damper shaft from the vise and vise blocks.

Clamp the lower ButterCups housing into a vise with RockShox Vise Blocks on the wrench flats, damper oriented upward.

Tighten the upper ButterCups housing onto the lower housing.

**⚠ WARNING - CRASH HAZARD**

Parts must be tightened to the specified torque. Failure to do so can result in **SERIOUS INJURY OR DEATH**.



25 mm

14 N·m (125 in·lb)

- 1 Rotate the adjuster tab counterclockwise until it stops. This is the full open position.  
Insert the IFP coil spring into the IFP damper tube. The spring will rest on top of the IFP.

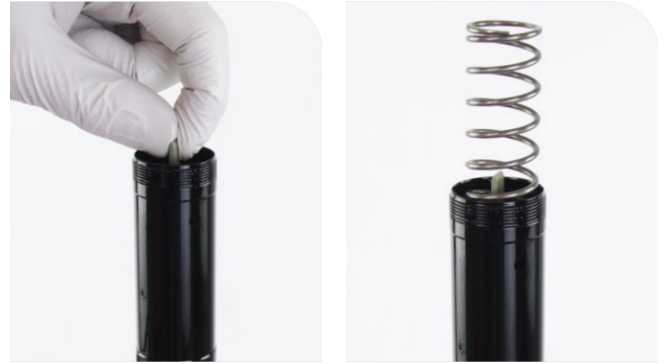

- 2 Position the ButterCups (Ultimate), or rebound damper shaft (Select+), end on a flat surface.  
Ultimate with ButterCups is pictured. The procedure is the same for Select+ without ButterCups.  
**Optional:** Clamp the ButterCups or rebound damper shaft end in the vise with Reverb Vise Blocks for added stability if needed.

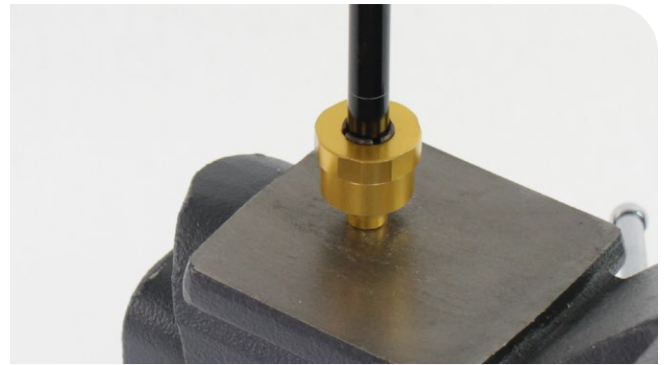

- 3 To purge oil from above the IFP, the IFP must be manually compressed into the IFP tube with the IFP spring, while the rebound damper is compressed and cycled into the cartridge damper tube.  
Locate the bleed line (C) on the rebound damper shaft. During the bleed process, the damper should be compressed to the bleed line (C), or to the total length (A) listed in the table below.

Fork	A - Total Damper Length (mm) when Compressed	B - Rebound Shaft / Fork Model Reference Number (printed on rebound damper shaft)
Pike Ultimate with ButterCups	360	100
Pike Select+ with no ButterCups		150
Lyrik Ultimate with ButterCups	377	200
Lyrik Select+ with no ButterCups		250
ZEB Ultimate with ButterCups	401	300
ZEB Select+ with no ButterCups		350

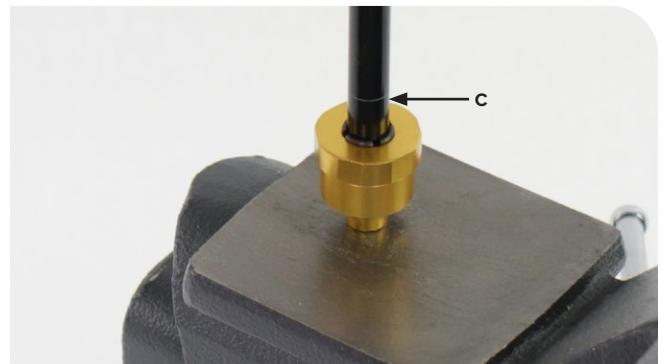
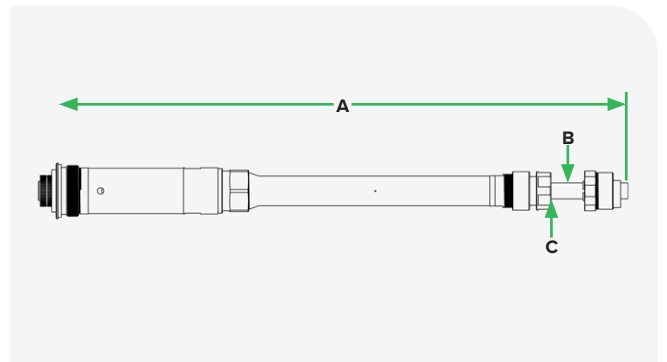

**4** Place a shop towel over the IFP spring.

Press the IFP coil spring down and into the IFP tube about half way, and hold it steady. This pushes the IFP into the IFP tube and applies opposing force, creating pressure within the cartridge tube.

**⚠ CAUTION**

Always wear safety glasses. Do not allow oil, fluid, grease, lubricant, or cleaner to contact your eyes or face. Seek immediate medical attention if irritation occurs.



**5** While holding the IFP spring compressed, slowly push the damper down about half way to the bleed line, then allow the damper to fully extend. Repeat this 2 more times, or until air cannot be heard moving through the damper.

**⚠ CAUTION**

Always wear safety glasses. Oil may exit the cartridge tube bleed hole when compressing the damper. Do not allow oil, fluid, grease, lubricant, or cleaner to contact your eyes or face. Seek immediate medical attention if irritation occurs.

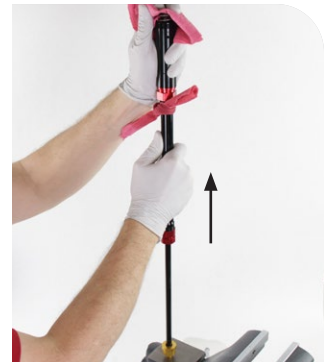
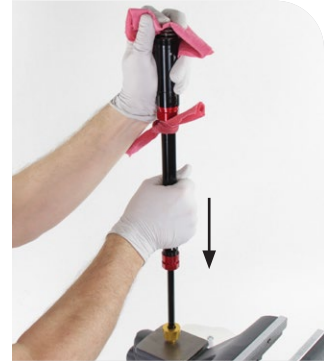
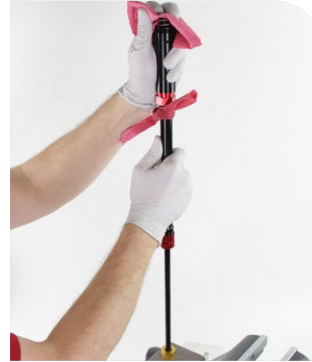

**6** While still holding the IFP spring compressed, slowly compress the damper until the rebound sealhead is even with the bleed line (A) on the rebound damper shaft. During the bleed process, the rebound damper must not be compressed further than the bleed line (A) on the rebound damper shaft.

A small amount of oil should purge from the bleed hole in the IFP tube.

Lift the damper up slowly, while maintaining pressure on the IFP spring, and allow the rebound damper to extend. Compressing the IFP will apply opposing pressure in the damper to allow the rebound damper to extend fully.

**Repeat this process 2 more times (3 total).**

The IFP tube may contain a small amount of oil after oil is purged from the bleed port. Pour out any remaining oil from the IFP tube into an oil pan before installing the top cap.

**⚠ CAUTION**

Always wear safety glasses. Oil may exit the cartridge tube bleed hole when compressing the damper. Do not allow oil, fluid, grease, lubricant, or cleaner to contact your eyes or face. Seek immediate medical attention if irritation occurs.

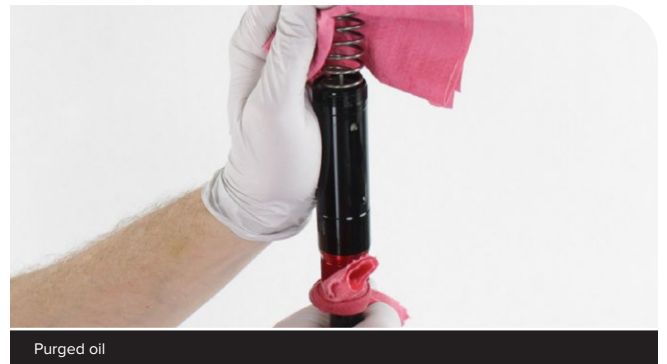
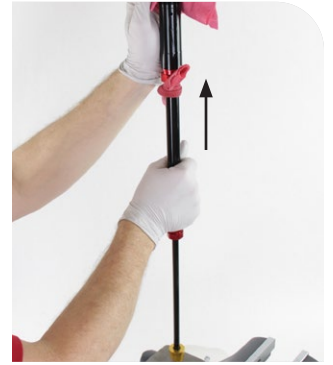
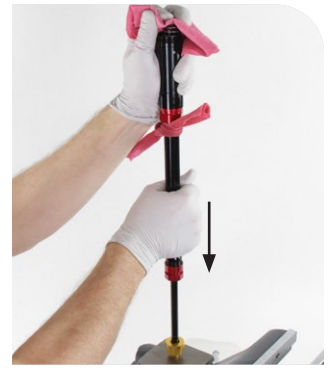



**7** Clamp the red coupler in the vise.

Align the keyed end of the compression adjuster under the top cap (A), with the (LSC) low speed compression damper adjuster tab (B).

While pushing down firmly and evenly, visually confirm the (LSC) low speed compression adjuster tab engages the mating (LSC) low speed compression damper adjuster tab.

Press the top cap down, compress the IFP spring, align the keyed parts, and engage the top cap threads slowly when the keyed parts are aligned and engaged.

Press down with the top cap tool and slowly thread the top cap onto the cartridge tube.

### NOTICE

The top cap threads will not engage if the keyed adjuster parts are not aligned and engaged.

Do not cross-thread the top cap and IFP tube.

### CAUTION

Always wear safety glasses. Use care when compressing the spring during top cap installation. Hold the top cap tightly and press straight down to prevent the top cap from slipping off the spring which can cause the spring, top cap, and oil to forcefully eject upward.

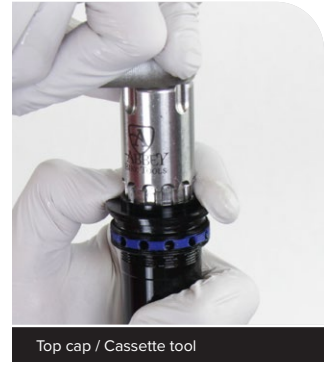
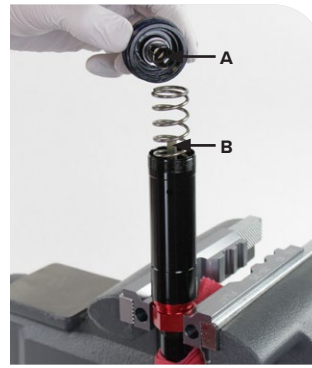

Top cap / Cassette tool

**8** When the threads are engaged properly, thread the top cap onto the IFP tube and tighten to torque.

### WARNING - CRASH HAZARD

Parts must be tightened to the specified torque. Failure to do so can result in SERIOUS INJURY OR DEATH.



Top cap / Cassette tool

14 N·m (125 in·lb)

**9** Remove the damper from the vise.

With the rebound damper oriented downward, clamp the rebound sealhead into the vise at the wrench flats.

Tighten the compression damper top cap to the specified torque.

### WARNING - CRASH HAZARD

Parts must be tightened to the specified torque. Failure to do so can result in SERIOUS INJURY OR DEATH.

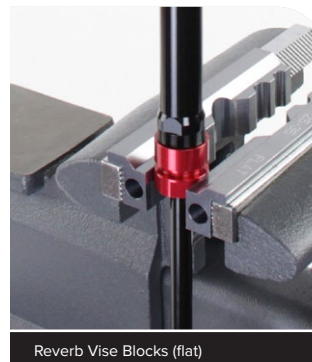

Reverb Vise Blocks (flat)

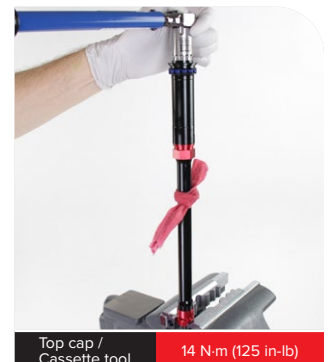

Top cap / Cassette tool

14 N·m (125 in·lb)

- 1 Temporarily install the LSC adjuster knob onto the compression adjuster. Install and tighten the retaining screw finger tight.  
Rotate the (LSC) low speed compression adjuster clockwise until it stops at the last detent, until it stops. This is the firmest LSC compression setting.

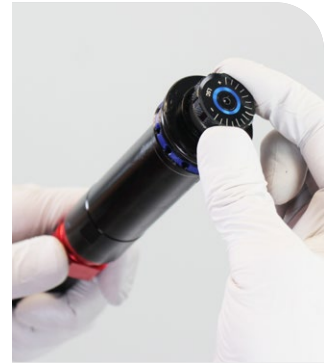
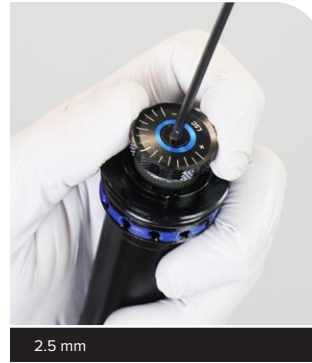

During the damper test process, the rebound damper must not be compressed further than the bleed line on the damper shaft.

Push the rebound damper into the cartridge tube slowly. Firm and consistent resistance should be felt with no gaps in movement. Do not push the rebound damper in further than the bleed line on the rebound damper shaft.

A small amount of oil may purge from the bleed port.

### **CAUTION**

Always wear safety glasses. Oil may exit the cartridge tube bleed hole when compressing the damper. Do not allow oil, fluid, grease, lubricant, or cleaner to contact your eyes or face. Seek immediate medical attention if irritation occurs.



Rotate the LSC compression adjuster counterclockwise to the full open setting and repeat the compression test. Light consistent resistance should be felt with no gaps in movement.

Cycle the rebound damper up and down with the compression adjuster in the full open position, until oil no longer purges from the bleed port.

If gaps are felt during compression, repeat the oil fill and bleed process. If the assembly process was successful, set the compression damper to the open setting.

Remove the shop towel and wipe away any oil from the damper assembly.

Remove the LSC adjuster knob when the test is complete.

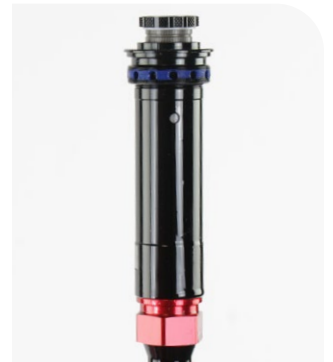
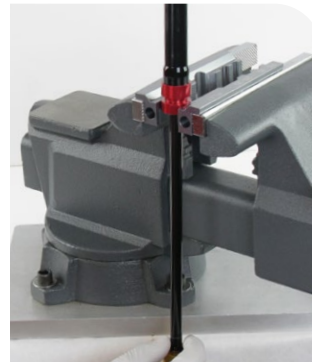

**Upgrade - Charger 3 RC2 Damper assembly with ButterCups:** Proceed to Step 2.

- 1 Remove the o-ring from the top cap.  
Clean the top cap threads and o-ring groove.

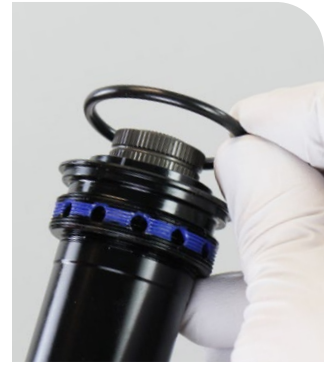

Apply grease to a new top cap o-ring and install it.



- 2 Install the damper assembly into the damper side upper tube. Use your fingers to guide the damper and damper shaft into the upper tube without scratching the shaft.

**NOTICE**

Do not scratch the rebound damper shaft. Scratches can cause oil to leak.



- 3 Thread the top cap into the upper tube and tighten it. Press down firmly when tightening the top cap.

**⚠ WARNING - CRASH HAZARD**

Parts must be tightened to the specified torque. Failure to do so can result in SERIOUS INJURY OR DEATH.



Top cap / Cassette tool

28 N·m (250 in-lb)



**UPGRADE - CHARGER 3 RC2 DAMPER WITH BUTTERCUPS**

To continue with the upgrade damper installation process, proceed to [Controls Installation - Charger 3 RC2](#).

- 1 Remove the white ring from the LSC knob and discard it.  
Clean the groove.  
Install a new white ring.

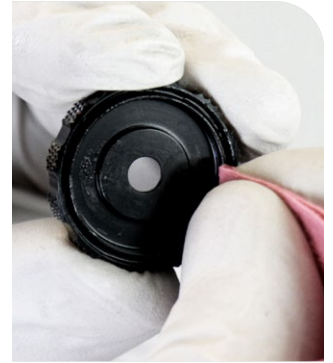

- 2 Install the High Speed Compression (HSC) knob detent plate with the alignment tick mark (A) oriented to the back of the crown, perpendicular to the steerer tube.





- 3** The High Speed Compression (HSC) and Low Speed Compression (LSC) adjuster knobs must be installed in the full clockwise/closed positions with the alignment marks oriented as indicated.

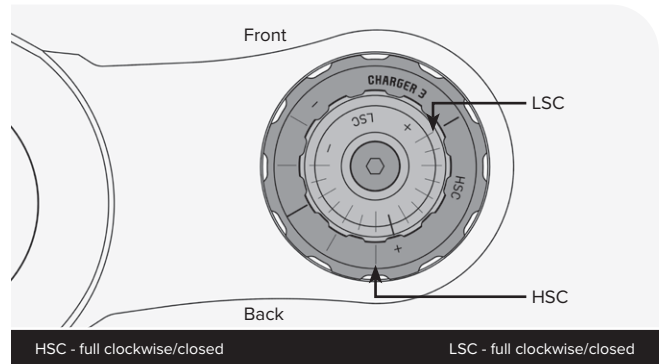

Rotate the large (HSC) High Speed Compression adjuster cam **clockwise**, by hand, until it stops.

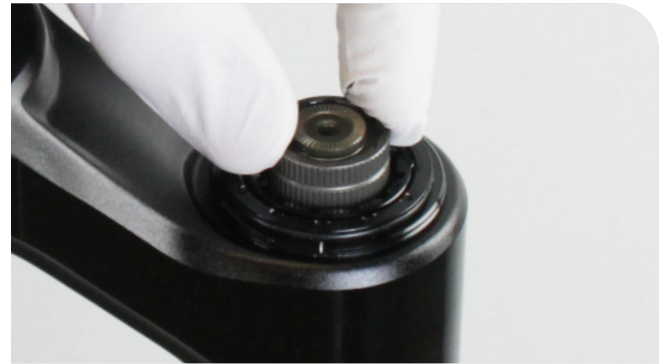

Install the HSC (LARGE) knob and align the (+) tick mark (A) with the alignment tick mark (B) on the detent plate at the back of the crown. Refer to the diagram above.

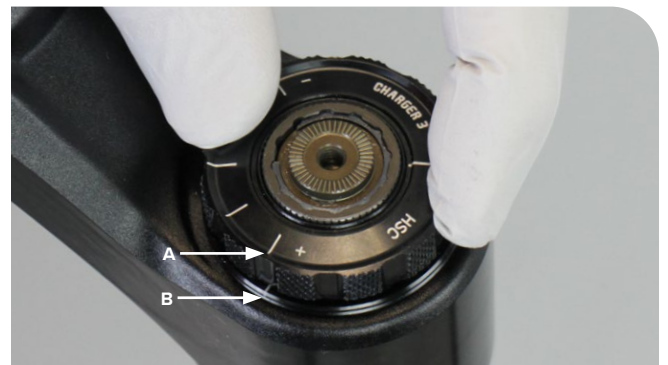

Tighten the HSC knob set screw.

Check function - Rotate the knob counterclockwise and confirm each detent tick mark aligns with the tick mark on the detent plate.

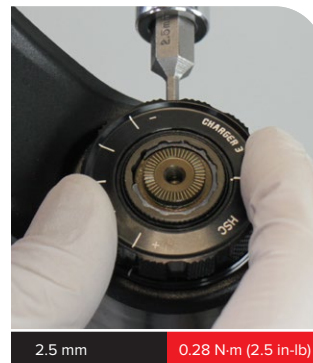



Rotate the LSC adjuster cam full **clockwise**, with a 2.5 mm hex wrench, until it stops.



Install and position the LSC adjuster knob and position the knob with the LSC (A) and HSC (B) alignment marks as pictured.



Hold the LSC adjuster knob in place and tighten the retaining screw.



Check function. Rotate the LSC (SMALL) knob counterclockwise and confirm each detent tick mark aligns with the tick mark on the HSC (LARGE) knob.



**200 Hour Service** Continue with [Lower Leg Installation](#).

**UPGRADE - CHARGER 3 RC2 DAMPER WITH BUTTERCUPS** To complete the damper upgrade installation process, proceed to [Lower Leg Installation](#).

### ⚠ CAUTION

Place an oil pan on the floor underneath the product during service to catch any drained or spilled fluids. To avoid a slip and fall, and possible injury or harm, immediately clean any oil, fluid, grease, or lubricant from the floor in your work area.

### NOTICE

Inspect each part for scratches. Do not scratch any sealing surfaces when servicing your suspension. Scratches can cause leaks.

When replacing seals and o-rings, use your fingers or a pick to remove the seal or o-ring. Spray RockShox Suspension Cleaner or isopropyl alcohol onto each part and clean with a clean lint-free shop towel.

Apply SRAM Butter grease to the new seals and o-rings.



SRAM Butter Grease

- 1 The compression damper must be in the full open position in order to perform bleed procedure.

Turn the compression adjuster knob counterclockwise, to the full open position, until it stop.

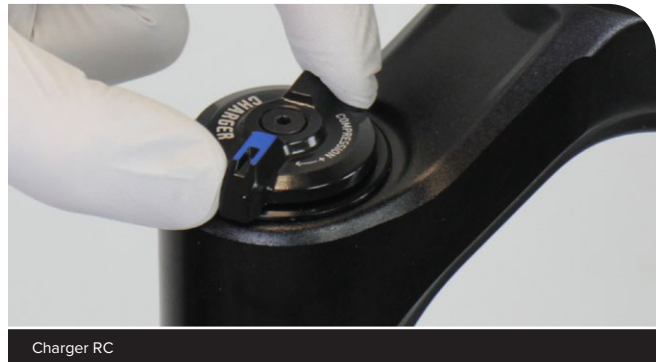

Charger RC

- 2 Remove the knob retaining screw and remove the adjuster knob.

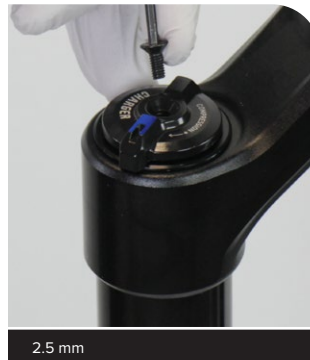

2.5 mm



- 1 Unthread the damper top cap and remove the damper assembly. Press down firmly when loosening the top cap.

**NOTICE**

The fork top caps are tightened to a high torque value. Ensure the fork is held securely in the bicycle stand. To avoid damage to the top cap, press the top cap / cassette tool squarely and firmly down when loosening. Use a socket wrench with a long handle for extra leverage.



- 2 Clean the inside and outside of the upper tube. Clean the upper tube threads.

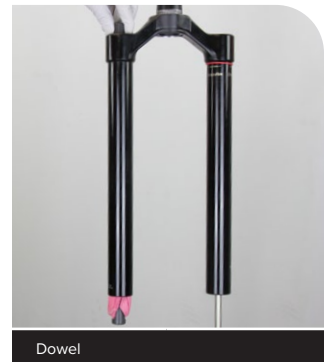
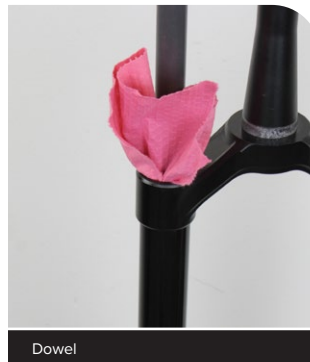

**UPGRADE - CHARGER 3 RC2 DAMPER WITH BUTTERCUPS** Select: To install a Charger 3 RC2 damper assembly with pre-installed ButterCups, proceed to [Damper Installation - Charger 3 RC2](#).

- 1 Clamp the cartridge tube in a vise with Charger Vise Blocks.

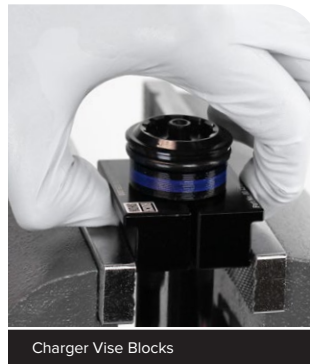

Charger Vise Blocks



- 2 Unthread the top cap from the tube.

**NOTICE**

The cartridge tube and vise blocks must be dry and free of oil to provide enough grip to unthread the top cap. If the cartridge tube slips, clean and dry the tube and vise blocks.



Top cap / Cassette tool

- 3 Wrap a shop towel around the cartridge tube under the top cap to absorb oil.

Carefully and slowly remove the compression damper.

**CAUTION**

Always wear safety glasses. Do not allow oil, fluid, grease, lubricant, or cleaner to contact your eyes or face. Seek immediate medical attention if irritation occurs.

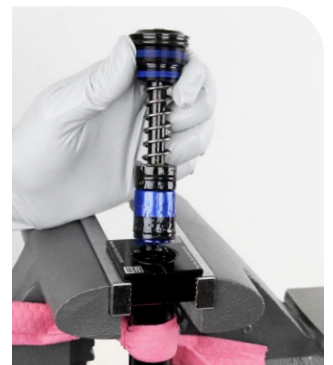

- 4 Remove the cartridge tube and rebound damper assembly from the vise and pour the oil into an oil pan.

Clean the exterior of the cartridge tube.



- 5** Clamp the cartridge tube into a vise with Charger Vise Blocks. Remove the rebound damper sealhead and rebound damper. Remove the cartridge tube from the vise.

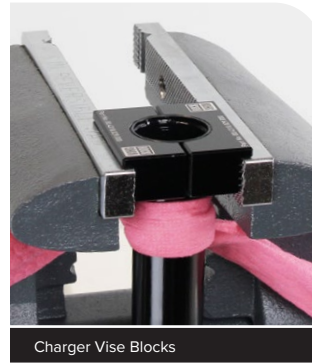

- 6** Remove the sealhead from the rebound damper shaft. Discard the sealhead.



- 7** Spray RockShox Suspension Cleaner or isopropyl alcohol into the cartridge tube and clean the inside of the tube with a clean shop towel and a thin dowel ( $\leq 16$  mm diameter).

Inspect the inside of the cartridge tube for scratches.

**NOTICE**

Scratches can cause oil to leak. Replace the cartridge tube if a scratch is visible.

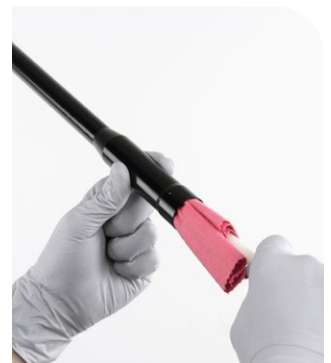



- 8 Remove the o-rings from the compression damper and discard them. Apply grease to new o-rings and install them.

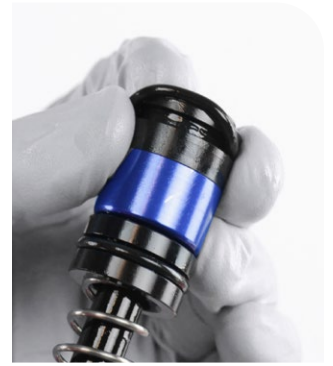
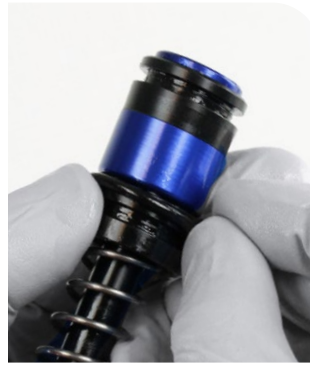

- 9 The solid band glide ring is not removable and only requires cleaning. Do not remove.

**NOTICE**

Do not remove the solid band glide ring. The solid band glide ring is not serviceable. Removal of the solid band glide ring will require a new damper assembly.

The color of the solid band glide ring may vary.





**10** Apply grease to the inner seal and bushing in the new rebound damper sealhead.

Apply grease to the end of the rebound damper shaft.

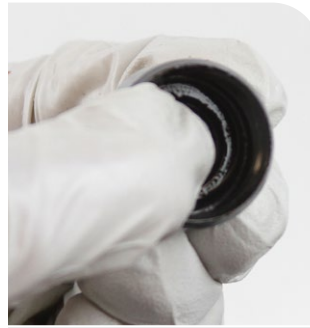

SRAM Butter Grease



SRAM Butter Grease

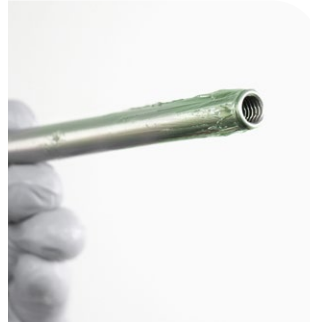

SRAM Butter Grease

- 1** Insert the rebound damper shaft into the recessed end of the sealhead.  
Slide the sealhead toward the piston.



- 2** Insert the rebound adjuster knob into the rebound damper shaft and rotate it counter clockwise until it stops. This is the full open position.



- 3** Clamp the sealhead into the vise.

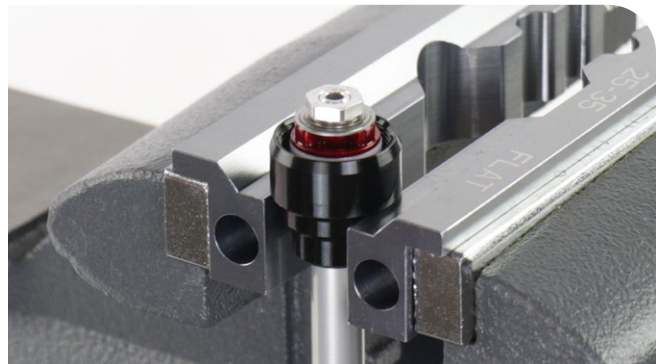

- 4** Insert the rebound damper shaft into the cartridge tube. Tighten the sealhead hand tight.

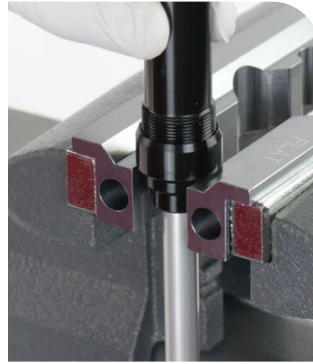
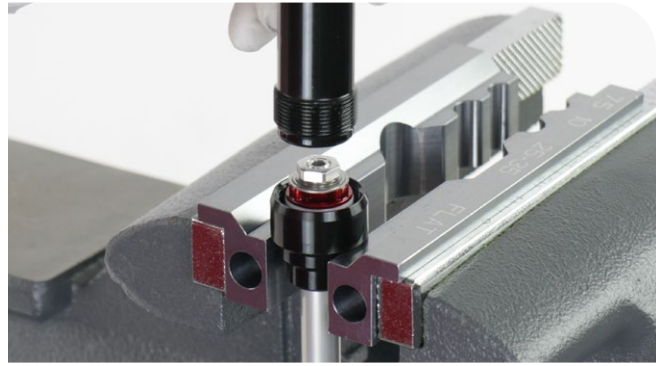

- 5** Pull the damper shaft to full extension.  
Thread a bottom bolt into the rebound damper shaft.



- 6** Secure a shop towel around the cartridge tube to absorb oil.  
Pour 3wt suspension oil into the tube until it is approximately half full.



Maxima PLUSH 3wt suspension oil

**7** Slowly cycle the rebound damper in and out half way to remove air bubbles trapped under the rebound damper piston.

Stop when no bubbles are visible in the oil.

**⚠ CAUTION**

Always wear safety glasses. Do not allow oil, fluid, grease, lubricant, or cleaner to contact your eyes or face. Seek immediate medical attention if irritation occurs.

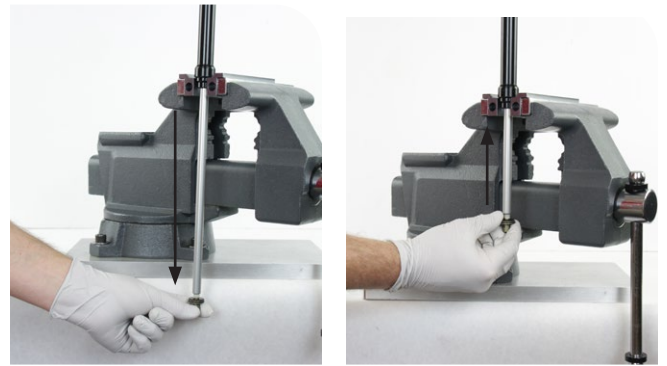

**8** Secure a plastic cable tie around the shaft **A (mm)** from the end of the shaft.

Push the rebound damper into the cartridge tube until there is **(A) mm** (length) of shaft extended. Do not push the damper into the tube any further.

Fork	Fork travel (mm)	A (mm)
<b>Pike</b>	120	92
	130	
	140	
<b>Lyrrik</b>	140	104
	150	
	160	
<b>ZEB</b>	150	100
	160	
	170	
	180	
	190	



See table

**9** Pour 3wt suspension oil into the tube until the oil is just below the (A) bleed holes.



Maxima PLUSH 3wt suspension oil

**10** Cover the bleed holes with the shop towel.

Apply Loctite Blue 242 threadlocker, or equivalent, onto two to three threads on the (A) compression damper top cap threads (lower threads).

**⚠ WARNING - CRASH HAZARD**

To avoid separation of parts, threadlocker must be applied as instructed. Failure to apply threadlocker could result in separation of the parts, and possible **SERIOUS INJURY OR DEATH**.

Insert the compression damper into the cartridge tube and slowly push it into the tube. The rebound damper will slowly extend as the compression damper is installed; this is normal.

Firmly push the compression damper down, into the cartridge tube. Thread the top cap into the tube.

**⚠ CAUTION**

Always wear safety glasses. Oil will exit the cartridge tube bleed hole when installing the damper. Do not allow oil, fluid, grease, lubricant, or cleaner to contact your eyes or face. Seek immediate medical attention if irritation occurs.



Threadlocker Loctite Blue 242 (blue) or equivalent

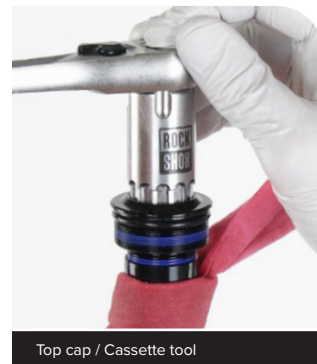
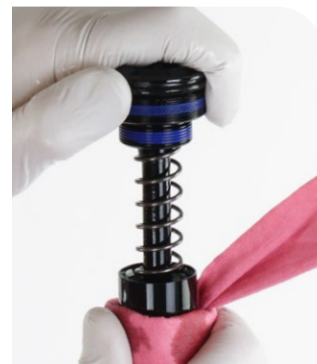

Top cap / Cassette tool

**11** Tighten the top cap to the specified torque. Press down firmly when tightening the top cap.

The rebound damper sealhead will be tightened onto the other end of the cartridge tube simultaneously.

**⚠ WARNING - CRASH HAZARD**

Parts must be tightened to the specified torque. Failure to do so can result in **SERIOUS INJURY OR DEATH**.



Top cap / Cassette tool

17 N·m (150 in-lb)

**12** Pull the rebound damper to full extension.

Secure a plastic cable tie around the shaft **A (mm)** from the end of the shaft.

Fork	Fork travel (mm)	A (mm)
<b>Pike</b>	120	25.5
	130	
	140	
<b>Lyrik</b>	140	23.5
	150	
	160	
<b>ZEB</b>	150	19
	160	
	170	
	180	
	190	

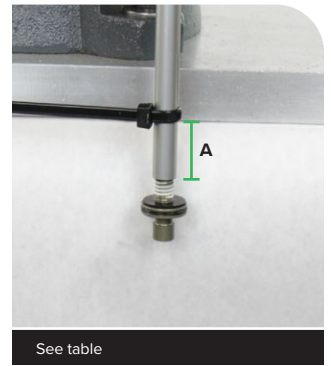
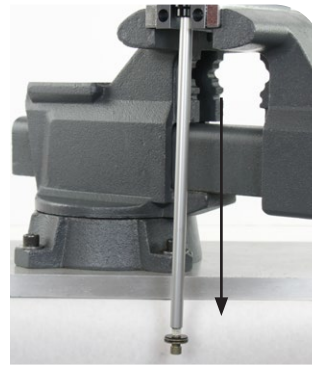

**13** Cover the bleed hole(s) with the secured towel.

**⚠ CAUTION**

Always wear safety glasses. Oil may exit the cartridge tube bleed hole when compressing the damper. Do not allow oil, fluid, grease, lubricant, or cleaner to contact your eyes or face. Seek immediate medical attention if irritation occurs.



Slowly push the rebound damper shaft into the tube until the cable tie contacts the sealhead, then stop. **Do not push the damper in any further.**

Slowly, pull the rebound shaft out to full extension.

Repeat 3-5 more times. This will allow any excess oil and air to escape from the system.

Remove the bottom bolt. Remove the damper assembly from the vise and clean it with a shop towel.

**Do not remove the cable tie.**





## Test Compression - Charger RC

- 1 Use the adjuster knob to rotate the compression cam clockwise, until it stops, to the firm position.

The cable tie must be **(A) mm** from the end of the shaft. **Do not compress the rebound damper further than this point.**

Fork	Fork travel (mm)	A (mm)
<b>Pike</b>	120	25.5
	130	
	140	
<b>Lyrik</b>	140	23.5
	150	
	160	
<b>ZEB</b>	150	19
	160	
	170	
	180	
	190	

Cover the oil bleed hole(s) with the secured towel.

### ⚠ CAUTION

Always wear safety glasses. Oil may exit the cartridge tube bleed hole when compressing the damper. Do not allow oil, fluid, grease, lubricant, or cleaner to contact your eyes or face. Seek immediate medical attention if irritation occurs.

Push down on the damper assembly slowly to test the firmest compression setting. Firm and consistent resistance should be felt with no gaps in movement.

Rotate the compression damper to the open setting and repeat the compression test. Light consistent resistance should be felt with no gaps in movement.

If gaps are felt during compression, repeat the oil fill and bleed process. If the assembly process was successful, set the compression damper to the open setting and remove the cable tie.

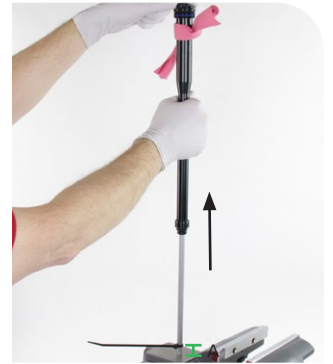

- 1 Remove the o-ring from the top cap.  
Clean the top cap threads and o-ring groove.  
Apply grease to a new o-ring and install it.

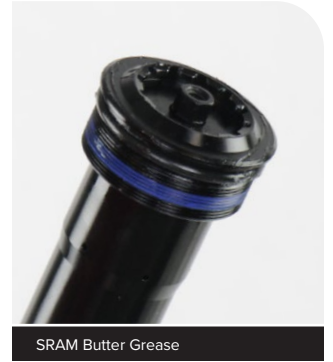

SRAM Butter Grease

- 2** Install the damper assembly into the damper side upper tube. Use your fingers to guide the damper and damper shaft into the upper tube without scratching the shaft.

**NOTICE**

Do not scratch the rebound damper shaft. Scratches can cause oil to leak.

Thread the top cap into the upper tube and tighten it. Press down firmly when tightening the top cap.

**⚠ WARNING - CRASH HAZARD**

Parts must be tightened to the specified torque. Failure to do so can result in SERIOUS INJURY OR DEATH.



Top cap / Cassette tool

28 N·m (250 in·lb)

- 1 Install the adjuster knob with the tab in the 7-8 o'clock, unlocked, position.

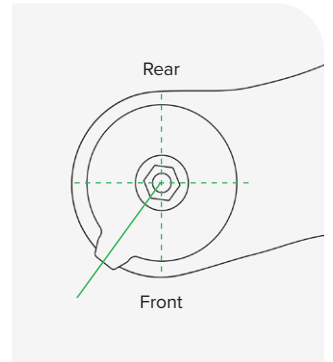

Install and tighten the retaining screw.



2.5 mm

1.35 N·m (12 in-lb)

 200 Hour Service Continue with [Lower Leg Installation](#).

**CAUTION**

Place an oil pan on the floor underneath the product during service to catch any drained or spilled fluids. To avoid a slip and fall, and possible injury or harm, immediately clean any oil, fluid, grease, or lubricant from the floor in your work area.

**NOTICE**

Inspect each part for scratches. Do not scratch any sealing surfaces when servicing your suspension. Scratches can cause leaks.

When replacing seals and o-rings, use your fingers or a pick to remove the seal or o-ring. Spray RockShox Suspension Cleaner or isopropyl alcohol onto each part and clean with a clean lint-free shop towel.

Apply SRAM Butter grease to the new seals and o-rings.



- 1 The compression damper must be in the full open position in order to perform the bleed procedure.  
Turn the compression adjuster knob counterclockwise, to the full open position, until it stops.



- 2 Remove the retaining screw and remove the knob.  
Remove the glide ring and o-ring. Clean the top cap grooves.

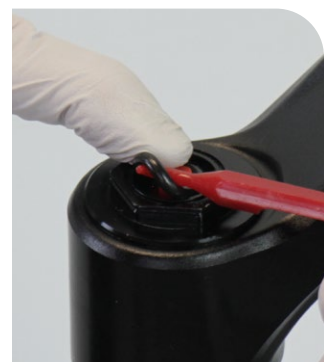

- 1 Unthread the damper top cap and remove the damper assembly. Press down firmly when loosening the top cap.

**NOTICE**

The fork top caps are tightened to a high torque value. Ensure the fork is held securely in the bicycle stand. To avoid damage to the top cap, press the top cap / cassette tool squarely and firmly down when loosening. Use a socket wrench with a long handle for extra leverage.

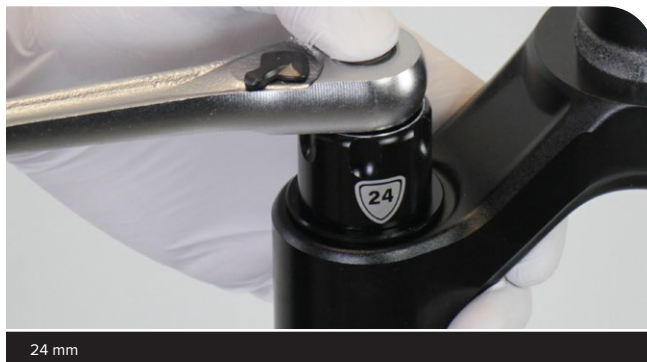

24 mm



- 2 Clean the inside and outside of the upper tube. Clean the upper tube threads.



RockShox Suspension Cleaner

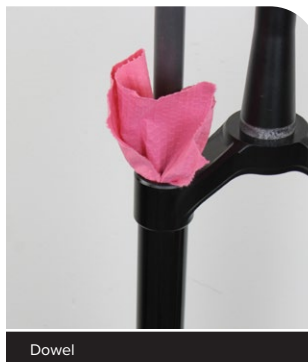

Dowel



Dowel



**UPGRADE - CHARGER 3 RC2 DAMPER WITH BUTTERCUPS** Base: To install a Charger 3 RC2 damper assembly with pre-installed ButterCups, proceed to [Damper Installation - Charger 3 RC2](#).



- 1 Clamp the cartridge tube in a vise with Reverb Vise Blocks.



- 2 Unthread the top cap from the tube.

**NOTICE**

The cartridge tube and vise blocks must be dry and free of oil to provide enough grip to unthread the top cap. If the cartridge tube slips, clean and dry the tube and vise blocks.

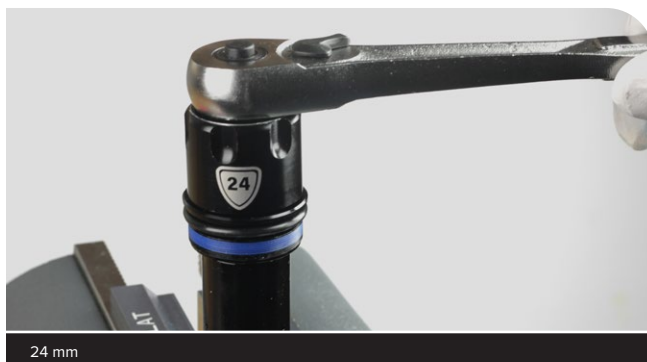

- 3 Wrap a shop towel around the cartridge tube under the top cap to absorb oil.

Carefully and slowly remove the compression damper.

**CAUTION**

Always wear safety glasses. Do not allow oil, fluid, grease, lubricant, or cleaner to contact your eyes or face. Seek immediate medical attention if irritation occurs.



- 4 Remove the cartridge tube and rebound damper assembly from the vise and pour the oil into an oil pan.

Clean the exterior of the cartridge tube.



- 5 Clamp the cartridge tube into a vise with Reverb Vise Blocks. Unthread and remove the rebound damper assembly.



- 6 The solid band glide ring is not removable and only requires cleaning. Do not remove.

**NOTICE**

Do not remove the solid band glide ring. The solid band glide ring is not serviceable. Removal of the solid band glide ring will require a new damper assembly.

The color of the solid band glide ring may vary.



- 7 Remove the sealhead from the rebound damper shaft. Discard the sealhead.



- 8 Spray RockShox Suspension Cleaner or isopropyl alcohol into the cartridge tube and clean the inside of the tube with a clean shop towel and a thin dowel ( $\leq 16$  mm diameter).

Inspect the inside of the cartridge tube for scratches.

**NOTICE**

Scratches can cause oil to leak. Replace the cartridge tube if a scratch is visible.

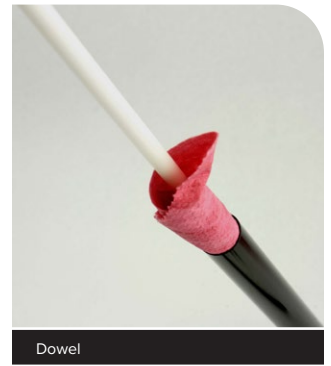
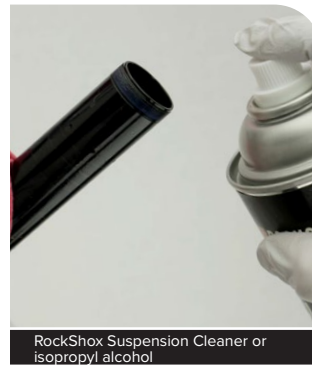

- 9 Remove the o-rings from the compression damper and discard them. Apply grease to new o-rings and install them.

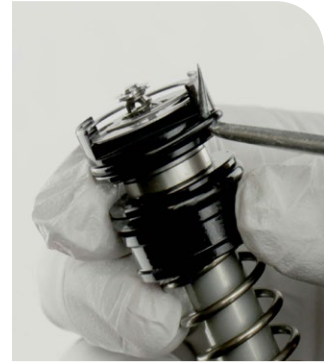

- 10 Apply grease to the inner seal and bushing in the new rebound damper sealhead.



**⚠ CAUTION**

Place an oil pan on the floor underneath the product during service to catch any drained or spilled fluids. To avoid a slip and fall, and possible injury or harm, immediately clean any oil, fluid, grease, or lubricant from the floor in your work area.

- 1 Apply grease to the rebound damper shaft. Insert the rebound damper shaft into the recessed end of the sealhead.

Slide the sealhead toward the piston.



- 2 Insert the rebound adjuster knob into the rebound damper and rotate it counterclockwise 16 clicks from the closed position. This is the full open position.



- 3 Thread the sealhead into the cartridge tube hand tight.  
Thread the bottom bolt into the rebound damper shaft.



- 4 Apply Loctite Blue 242 threadlocker, or equivalent, onto two to three (A) cartridge tube threads.

**⚠ WARNING - CRASH HAZARD**

To avoid separation of parts, threadlocker must be applied as instructed. Failure to apply threadlocker could result in separation of the parts, and possible **SERIOUS INJURY OR DEATH**.

Clamp the cartridge tube into a vise with Reverb Vise Blocks. Pull the damper shaft to full extension.

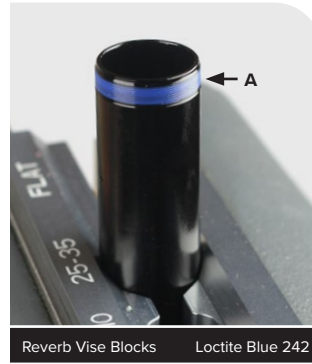

- 5 Pour Maxima PLUSH 3wt suspension oil into the tube until it is almost half full. Slowly cycle the rebound damper shaft in and out half way to remove air bubbles trapped under the rebound damper piston. Stop when no bubbles are visible in the oil.

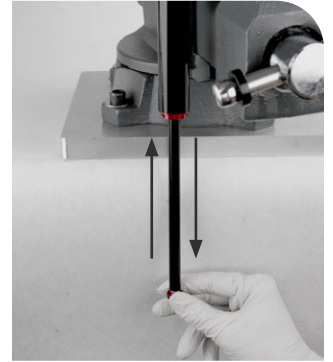
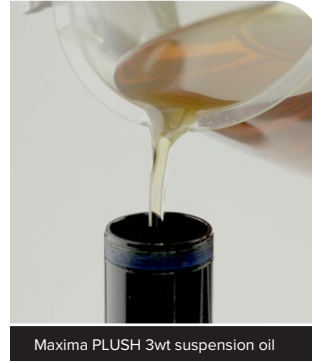

- 6 Push the rebound damper into the cartridge tube until the rebound shaft is at the (A mm) measurement.

Do not push the rebound damper into the tube any further.

Fork	Fork travel (mm)	A (mm)
<b>Pike</b>	120	70
	130	
<b>Pike / Lyrik</b>	140	
<b>Lyrik</b>	150	
	160	
<b>ZEB</b>	150	94
	160	
	170	
	180	
	190	

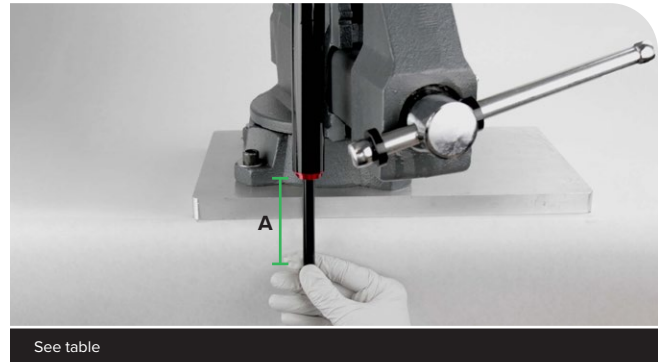

- 7 Pour Maxima PLUSH 3wt suspension oil into the tube until the oil is just below the bleed holes (A).





- 8 Secure a shop towel around the damper to absorb oil. Insert the compression damper into the cartridge tube and slowly push it into the tube. The rebound damper will slowly extend as the compression damper is installed; this is normal.

Firmly push down and thread the top cap into the tube.

**⚠ CAUTION**

Always wear safety glasses. Oil will exit the cartridge tube bleed hole when installing the damper. Do not allow oil, fluid, grease, lubricant, or cleaner to contact your eyes or face. Seek immediate medical attention if irritation occurs.



- 9 Tighten the top cap. Press down firmly when tightening the top cap.

Tighten the rebound damper sealhead.

Remove the damper assembly from the vise.

**⚠ WARNING - CRASH HAZARD**

Parts must be tightened to the specified torque. Failure to do so can result in SERIOUS INJURY OR DEATH.

**NOTICE**

Do not scratch the rebound damper shaft. Scratches can cause oil to leak.

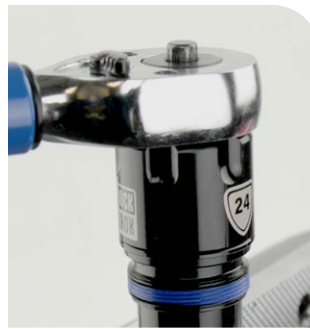

24 mm

17 N·m (150 in·lb)



19 mm

17 N·m (150 in·lb)



**10** Remove the damper from the vise. Secure a shop towel loosely around the damper cartridge over the bleed holes. Hold the damper vertical and slowly pull the shaft out to full extension.

Remove the bottom bolt.

Slowly push the rebound damper shaft into the cartridge tube until the rebound damper shaft is at the "B" measurement. Do not push the rebound damper into the tube any further.

Fork	Fork travel (mm)	B (mm)
<b>Pike</b>	120	30
	130	
<b>Pike / Lyrik</b>	140	
<b>Lyrik</b>	150	
	160	
<b>ZEB</b>	150	
	160	
	170	
	180	
	190	

Extend the damper and push down to the "B" measurement 3-5 more times. This will allow any excess oil and air to escape from the system.

Clean the damper.

**⚠ CAUTION**

Always wear safety glasses. Oil may exit the cartridge tube bleed hole when compressing the damper. Do not allow oil, fluid, grease, lubricant, or cleaner to contact your eyes or face. Seek immediate medical attention if irritation occurs.

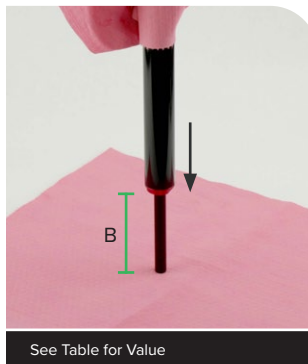

See Table for Value

- 1 Use the compression adjuster knob to rotate the adjuster cam to the closed position, full clockwise until it stops.

Cover the bleed holes with a shop towel.

### **CAUTION**

Always wear safety glasses. Oil may exit the cartridge tube bleed hole when compressing the damper. Do not allow oil, fluid, grease, lubricant, or cleaner to contact your eyes or face. Seek immediate medical attention if irritation occurs.

Push down on the damper assembly slowly, about half way, to test the firmest compression setting. Firm and consistent resistance should be felt with no gaps in movement.

Rotate the compression damper to open setting and repeat the compression test. Light consistent resistance should be felt with no gaps in movement.

If gaps are felt during compression, repeat the oil fill and bleed process. If the assembly process was successful, set the compression damper to the open setting and remove the cable tie.

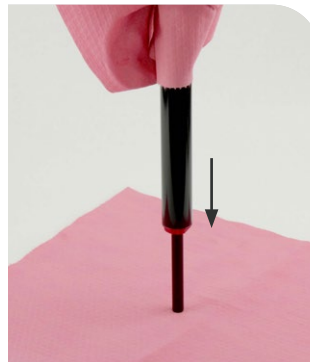

- 1 Remove the o-ring from the top cap.  
Clean the top cap threads and o-ring groove.  
Apply grease to a new o-ring and install it.

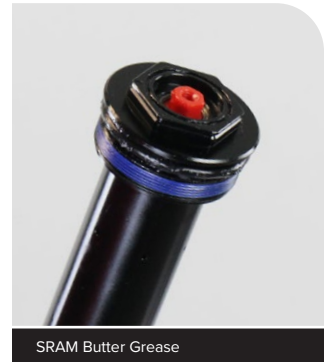
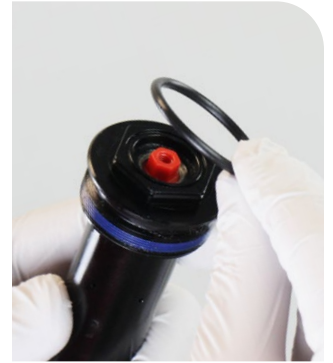

SRAM Butter Grease

- 2** Install the damper assembly into the damper side upper tube. Use your fingers to guide the damper and damper shaft into the upper tube without scratching the shaft.

**NOTICE**

Do not scratch the rebound damper shaft. Scratches can cause oil to leak.

Thread the top cap into the upper tube and tighten it. Press down firmly when tightening the top cap.

**⚠ WARNING - CRASH HAZARD**

Parts must be tightened to the specified torque. Failure to do so can result in **SERIOUS INJURY OR DEATH**.



24 mm

28 N-m (250 in-lb)

- 1 Apply grease and install a new o-ring and glide ring. Install the glide ring into the groove and the o-ring in the center pocket of the top cap.



- 2 Install the adjuster knob with the tab in the 7-8 o'clock, unlocked position.  
Install and tighten the retaining screw.

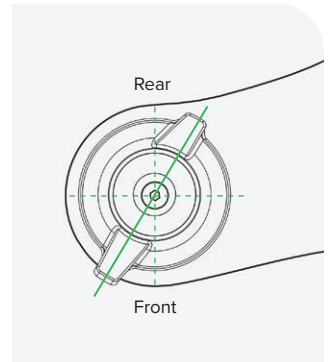

2.5 mm

0.75 - 1.10 N·m (6.6 - 9.7 in-lb)

**1** Clean the upper tubes.

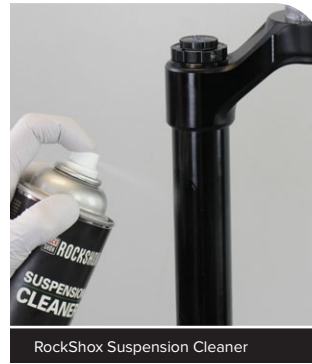

**2** Apply grease to the inner surfaces of the dust wiper seals.





- 3 Install the lower leg assembly onto the upper tubes and slide it just enough to engage the upper bushings with the upper tubes.

**NOTICE**

Make sure both wiper seals slide onto the tubes without folding the outer lip of either seal.

The inside bottom of the lower leg should not contact the air spring shaft and damper shaft, or ButterCups(s) (Ultimate). A gap between the shafts, or ButterCups(s) (Ultimate), and the lower leg bolt holes should be visible.



- 4 Position the fork at an angle with the bolt holes oriented upward. Inject Maxima PLUSH Dynamic Suspension Lube Light into each lower leg through the bottom bolt holes.

**NOTICE**

Do not exceed the recommended oil volume per leg as this can damage the fork.

Fork	Damper Side (mL)	Spring Side (mL)
ZEB	30	15
Lyrik		
Pike		

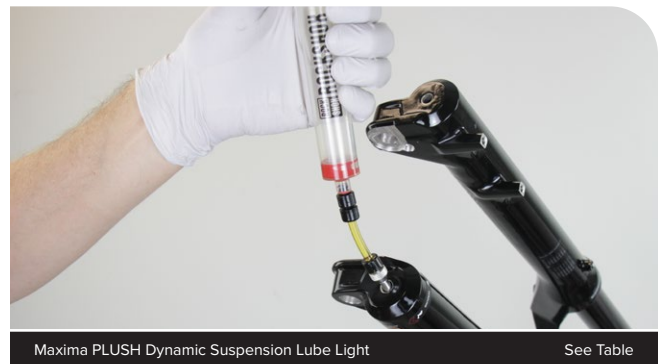

Maxima PLUSH Dynamic Suspension Lube Light

See Table

- Slide the lower leg assembly toward the crown until it contacts the shaft ends, and it stops.



The air spring and damper shaft, or ButterCups(s) (Ultimate) should be visible through the bottom bolt holes.

Verify each shaft or ButterCups (Ultimate) is centered and seated in the lower leg shaft/bolt hole, and no gap is visible between the lower leg and each threaded shaft or ButterCups (Ultimate).

Align the shaft or ButterCups (Ultimate) into the bottom bolt holes if needed.



- 200 Hour Service** Remove the old crush washers from each bottom bolt.

Hold the crush washer with needle nose pliers and unthread it from the bolt by turning the bolt counterclockwise. Discard the crush washers.

Clean the bolts and install new crush washers.

### NOTICE

Do not damage the bolt threads.

Do not reuse crush washers or crush washer retainers. Dirty or damaged crush washers can cause oil to leak from the fork.

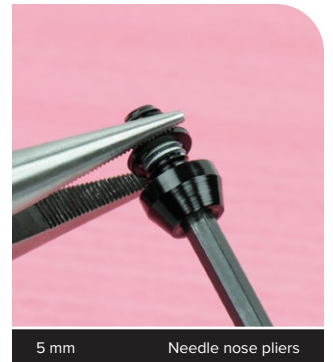
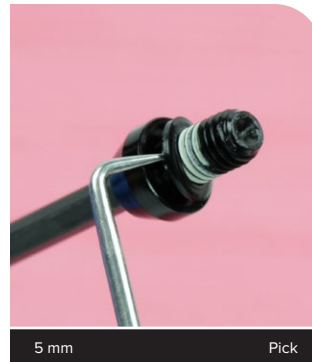

- 7** Install the solid bottom bolt into the spring side shaft.  
 Install the hollow bolt into the damper side shaft.  
 Tighten each bolt.

**⚠ WARNING - CRASH HAZARD**

Parts must be tightened to the specified torque. Failure to do so can result in SERIOUS INJURY OR DEATH.



5 mm Spring side



5 mm 6.8 N-m (60 in-lb)

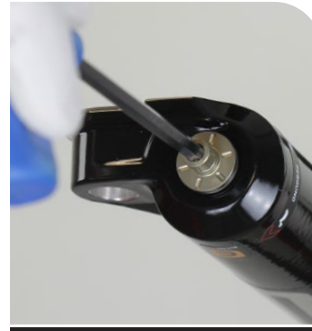

5 mm Damper side



5 mm 6.8 N-m (60 in-lb)

- 8** Apply a small amount of grease to the end of the rebound adjuster rod to assist with installation.  
 Install the rebound adjuster knob onto the rebound damper bottom bolt.  
 Press the knob firmly onto the bolt until it clicks into place.  
 Tighten the set screw.  
 Refer to your pre-service recorded rebound setting to adjust the rebound damping.



SRAM Butter Grease RC2



2.5 mm 0.84 N-m (7.5 in-lb)



SRAM Butter Grease RC



2.5 mm 0.84 N-m (7.5 in-lb)

- 9** Refer to your pre-service recorded settings, or use the air chart on the fork's lower leg, and pressurize the air spring.

*You may see a drop in the indicated air pressure on the pump gauge while filling the air spring; this is normal. Continue to fill the air spring to the recommended air pressure.*

Compressing the fork will equalize the positive and negative air chambers. After the fork is cycled 3-4 times, check the pressure and add air as needed.



Shock pump

- 10** Install the air valve cap.



DebonAir+



DebonAir+



Dual Position Air



Dual Position Air

- 11** Clean the entire fork.



RockShox Suspension Cleaner



**This concludes the service of your RockShox suspension fork.**

---

ASIAN HEADQUARTERS

SRAM Taiwan  
No. 1598-8 Chung Shan Road  
Shen Kang Hsiang, Taichung City  
Taiwan

WORLD HEADQUARTERS

SRAM, LLC  
1000 W. Fulton Market, 4th Floor  
Chicago, Illinois 60607  
U.S.A.

EUROPEAN HEADQUARTERS

SRAM Europe  
Paasbosweg 14-16  
3862ZS Nijkerk  
The Netherlands